

SECONDARY HANDRAIL SYSTEMS



DekPro™ Prestige
Aluminum Textured
Secondary Handrail

pg 106 - 108

Fortress™
Aluminum Secondary
Handrail

pg 109 - 111

Solutions™
Aluminum Secondary
Handrail

pg 112 - 115

ACTUAL FREIGHT CHARGES APPLY TO ALL DEKPROTM PRESTIGE RAIL ORDERS

1-1/2" DekProTM Prestige Round Aluminum Handrail - Textured

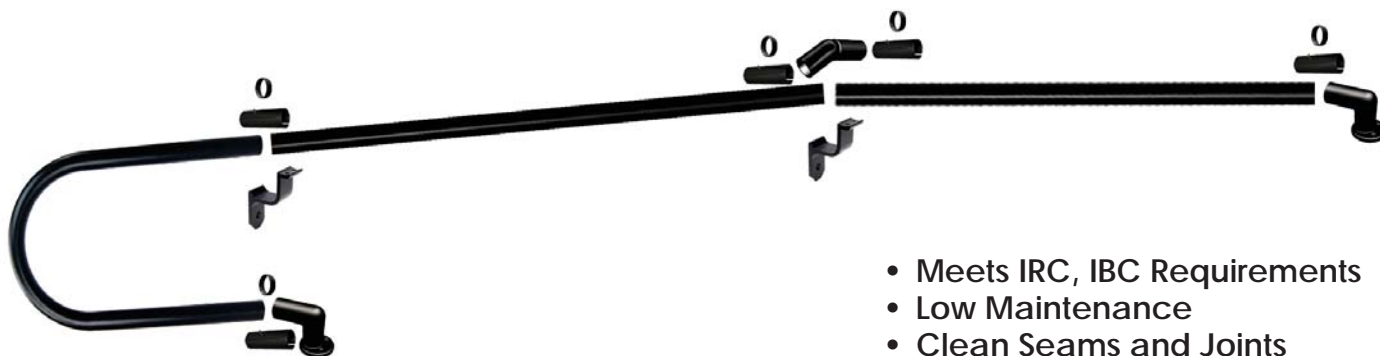

- Meets IRC, IBC Requirements
- Low Maintenance
- Clean Seams and Joints
- Sturdy and Rigid
- ADA Handicap Compliant
- Commercial Quality Railing



- Available in:
- Absolute Black
 - Cocoa Bronze
 - Dream White
 - Maple Cream
 - Silver



96" & 92" - Straight Round Handrail

Sold in any quantity.

1-1/2" round graspable handrail meets IRC requirements for secondary handrail system. Installs with screws or adhesive. 92" rail saves on oversize shipping charges if shipping without pallet order.

- | | |
|--------------------------------------|-----------------------------------|
| Item # PR1596SHRABT - Absolute Black | Item # PR1592SHRABT - Black |
| Item # PR1596SHRCBT - Cocoa Bronze | Item # PR1592SHRCBT - Bronze |
| Item # PR1596SHRDWT - Dream White | Item # PR1592SHRDWT - White |
| Item # PR1596SHRMCT - Maple Cream | Item # PR1592SHRMCT - Maple Cream |
| Item # PR1596SHRSILVER - Silver | Item # PR1592SHRSILVER - Silver |



- Available in:
- Absolute Black
 - Cocoa Bronze
 - Dream White
 - Maple Cream
 - Silver



Universal Quick Return Bracket Kit

Sold in any quantity.

Returns 1-1/2" round handrail into post or wall. Works for any surface 2" or wider. Includes a handrail splice kit to connect to rail and color matched screws. Installs with screws or adhesive.

- | |
|---------------------------------------|
| Item # PRSHRQRABTKIT - Absolute Black |
| Item # PRSHRQRCBTKIT - Cocoa Bronze |
| Item # PRSHRQRDWTKIT - Dream White |
| Item # PRSHRQRMCTKIT - Maple Cream |
| Item # PRSHRQRSILVERKIT - Silver |



- Available in:
- Absolute Black
 - Cocoa Bronze
 - Dream White
 - Maple Cream
 - Silver



Universal Mid-Rail Bracket

Sold in any quantity.

Attaches 1-1/2" round handrail to post or wall. Includes color matched screws. Mounts to any flat surface 2" or wider. Adjustable to any angle.

- | |
|--------------------------------------|
| Item # PRSHMRBKTABT - Absolute Black |
| Item # PRSHMRBKTGBT - Cocoa Bronze |
| Item # PRSHMRBKT DWT - Dream White |
| Item # PRSHMRBKT MCT - Maple Cream |
| Item # PRSHMRBKT SILVER - Silver |



ACTUAL FREIGHT CHARGES APPLY TO ALL DEKPRO™ PRESTIGE RAIL ORDERS



- Available in:
- Absolute Black
 - Cocoa Bronze
 - Dream White
 - Maple Cream



Wall Mount Bracket

Sold in any quantity.

Attaches 1-1/2" round handrail straight into post or wall. Works for any surface 3-1/2" or wider. Includes a handrail splice kit to connect to rail and color matched screws. Installs with screws or adhesive.

- Item # PRSHRWALLMTABT - Absolute Black
- Item # PRSHRWALLMTCBT - Cocoa Bronze
- Item # PRSHRWALLMTDWT - Dream White
- Item # PRSHRWALLMTMCT - Maple Cream



- Available in:
- Absolute Black
 - Cocoa Bronze
 - Dream White
 - Maple Cream
 - Silver



Handrail Splice Kit

Sold in any quantity.

Splice kit joins straight 1-1/2" round handrail sections. Kit includes 1 splice and 1 splice ring. Splice ring is used to conceal the connection point. Installs with screws or adhesive.

- Item # PRSHRSPLICEABTKIT - Absolute Black
- Item # PRSHRSPLICECBTKIT - Cocoa Bronze
- Item # PRSHRSPLICEDWTKIT - Dream White
- Item # PRSHRSPLICEMCTKIT - Maple Cream
- Item # PRSHRSPLICESILVERKIT - Silver



- Available in:
- Absolute Black
 - Cocoa Bronze
 - Dream White
 - Maple Cream
 - Silver



Multi-Angle Handrail Connector Kit

Sold in any quantity.

Connector kit joins 1-1/2" round handrail sections to allow for multi-angle connections to be made. Typically used for stair applications. Kit includes 1 multi-angle connector, 2 splices, and 2 splice rings. Installs with screws or adhesive.

- Item # PRSHRUABTKIT - Absolute Black
- Item # PRSHRUACBTKIT - Cocoa Bronze
- Item # PRSHRUADWTKIT - Dream White
- Item # PRSHRUAMCTKIT - Maple Cream
- Item # PRSHRUASILVERKIT - Silver



- Available in:
- Absolute Black
 - Cocoa Bronze
 - Dream White
 - Maple Cream
 - Silver



90° Elbow - Inside/Outside Corner

Sold in any quantity.

90 degree rail used for inside and outside corner applications. **Requires a straight handrail splice at each end. (Sold Separately).** Each side has 12" of rail. Installs with screws or adhesive.

- Item # PRSHRINSIDECABT - Absolute Black
- Item # PRSHRINSIDECBCT - Cocoa Bronze
- Item # PRSHRINSIDECDWT - Dream White
- Item # PRSHRINSIDECMCT - Maple Cream
- Item # PRSHRINSIDECSILVER - Silver



- Available in:
- Absolute Black
 - Cocoa Bronze
 - Dream White
 - Maple Cream
 - Silver



Inside Corner Bracket

Sold in any quantity.

Attaches 1-1/2" round 90° elbow inside corner rail to corner of post. Includes color matched screws.

- Item # PRSHRINSIDECBKTABT - Absolute Black
- Item # PRSHRINSIDECBKTCBT - Cocoa Bronze
- Item # PRSHRINSIDECBKTDWT - Dream White
- Item # PRSHRINSIDECBKTMCT - Maple Cream
- Item # PRSHRINSIDECBKTSILVER - Silver



ACTUAL FREIGHT CHARGES APPLY TO ALL DEKPRO™ PRESTIGE RAIL ORDERS



- Available in:
- Absolute Black
 - Cocoa Bronze
 - Dream White
 - Maple Cream
 - Silver
- 

P-Loop Return - ADA Compliant

Sold in any quantity.

180 degree handrail end loop is used to extend beyond post and return back to post. **Requires a handrail splice and 2 brackets to complete installation.** Installs with screws or adhesive.



- Item # PRSHRPLOOPABT - Absolute Black
- Item # PRSHRPLOOPCBT - Cocoa Bronze
- Item # PRSHRPLOOPDWT - Dream White
- Item # PRSHRPLOOPMCT - Maple Cream
- Item # PRSHRPLOOPSILVER - Silver



- Available in:
- Absolute Black
 - Cocoa Bronze
 - Dream White
 - Maple Cream
 - Silver
- 

End Cap

Sold in any quantity.

Finishes end of handrail if not attaching back to post. Installs with screws or adhesive.

- Item # PRSHRENDCAPABT - Absolute Black
- Item # PRSHRENDCAPCBT - Cocoa Bronze
- Item # PRSHRENDCAPDWT - Dream White
- Item # PRSHRENDCAPMCT - Maple Cream
- Item # PRSHRENDCAPSILVER - Silver



- Available in:
- Absolute Black
 - Cocoa Bronze
 - Dream White
 - Maple Cream
- 

Prestige Touch Up Paint

Sold in any quantity.

Sold in 11 oz. spray can or .3 oz. paint pen to touch up rails.

Spray Can (11 oz):

- Item # PRPAINT12ABT - Black
- Item # PRPAINT12CBT - Bronze
- Item # PRPAINT12DWT - White
- Item # PRPAINT12MCT - Maple

Paint Pen:

- Item # PRPAINTPENABT - Black
- Item # PRPAINTPENCBT - Bronze
- Item # PRPAINTPENDWT - White
- Item # PRPAINTPENMCT - Maple



RailFX™ Railing w/ Secondary Handrail - Absolute Black

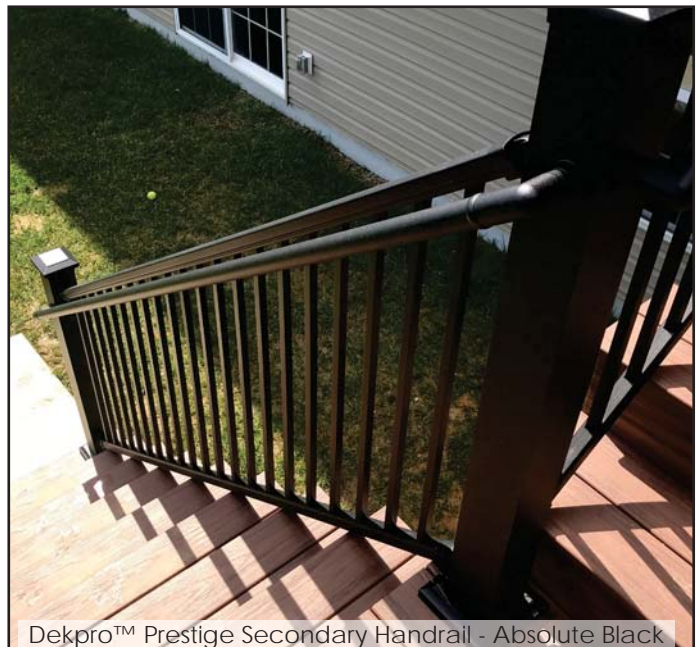

Dekpro™ Prestige Secondary Handrail - Absolute Black

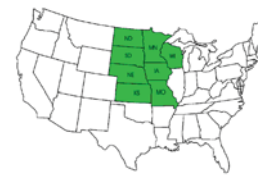

ACTUAL FREIGHT CHARGES APPLY TO ALL FORTRESSTM RAIL ORDERS

1-1/2" FortressTM Al¹³ Round Aluminum Handrail



Assemble secondary handrail using 2 part epoxy (No fasteners required)



Available in:

Black Sand

Ant. Bronze

White

8' - Al¹³ Aluminum Round Handrail

Sold in any quantity.

1-1/2 x 8' round graspable handrail meets IRC requirements for secondary handrail system.

Item # 50500938 - Black Sand (Textured)

Item # 50500936 - Antique Bronze

Item # 50500931 - White



Available in:

Black Sand

Ant. Bronze

White

Al¹³ Aluminum Round Handrail Return Bracket

Sold in any quantity.

Returns 1-1/2" round handrail into post or wall. Works for any surface 2" or more. **Requires a straight handrail splice to connect to handrail (see next page).** Includes color matched screws.

Item # 50500058 - Black Sand (Textured)

Item # 50500056 - Antique Bronze

Item # 50500051 - White



Available in:

Black Sand

Ant. Bronze

White

Al¹³ Aluminum Round Mid-Rail Bracket

2/Pack

Attaches 1-1/2" round handrail to post or wall. Includes color matched screws for wood and metal. Sold as pair.

Item # 50500018 - Black Sand (Textured)

Item # 50500016 - Antique Bronze

Item # 50500011 - White

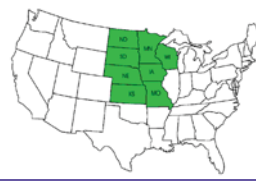

ACTUAL FREIGHT CHARGES APPLY TO ALL FORTRESSTM RAIL ORDERS



- Available in:
- Black Sand
 - Ant. Bronze
 - White

AI¹³ Aluminum Round Handrail Splice

Sold in any quantity.

Splice Joins 1-1/2" round handrail sections. Middle trim ring conceals splice. No hardware required, use 2 part epoxy for installation.

- Item # 50500048 - Black Sand (Textured)
- Item # 50500046 - Antique Bronze
- Item # 50500041 - White



- Available in:
- Black Sand
 - Ant. Bronze
 - White

AI¹³ Aluminum Round Handrail Angle Adjuster

Sold in any quantity.

Angle adjuster may be used to adjust to appropriate stair angle. No hardware required, use 2 part epoxy for installation.

- Item # 50501038 - Black Sand (Textured)
- Item # 50501036 - Antique Bronze
- Item # 50501031 - White



- Available in:
- Black Sand
 - Ant. Bronze
 - White

AI¹³ Aluminum Round Handrail 90° Elbow

Sold in any quantity.

90 Degree corner used to transition around post, must use handrail splice to attach to handrail. No hardware required, use 2 part epoxy for installation.

- Item # 50500028 - Black Sand (Textured)
- Item # 50500026 - Antique Bronze
- Item # 50500021 - White



- Available in:
- Black Sand
 - Ant. Bronze
 - White

AI¹³ Aluminum Round Handrail Corner Bracket

Sold in any quantity.

Attaches 1-1/2" round handrail to corner of post. Includes color matched screws.

- Item # 50500118 - Black Sand (Textured)
- Item # 50500116 - Antique Bronze
- Item # 50500111 - White



- Available in:
- Black Sand
 - Ant. Bronze
 - White

AI¹³ Aluminum Round Handrail P-Loop

Sold in any quantity.

180 Degree Handrail end loop is used to extend beyond post and return back to post. Handrail splice, mid rail bracket, and return bracket are required to complete installation. No hardware required, use 2 part epoxy for installation.

- Item # 50501028 - Black Sand (Textured)
- Item # 50501026 - Antique Bronze
- Item # 50501021 - White



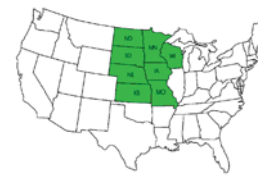

ACTUAL FREIGHT CHARGES APPLY TO ALL FORTRESSTM RAIL ORDERS



Available in:

- Black Sand
- Ant. Bronze
- White

AI¹³ Aluminum Round Handrail End Cap

2/Pack

Finishes end of handrail, use 2 part epoxy for installation.

- Item # 50500038 - Black Sand (Textured)
- Item # 50500036 - Antique Bronze
- Item # 50500031 - White



Available in:

- Black Sand
- Ant. Bronze
- White

AI¹³ Touch Up Paint

Sold in any quantity.

Available in two convenient sizes.

Spray Can - 6oz:

- Item # 660378 - Black Sand
- Item # 660376 - Antique Bronze
- Item # 660371 - White

Paint Pen

- Item # 660368 - Black Sand
- Item # 660366 - Antique Bronze
- Item # 660361 - White

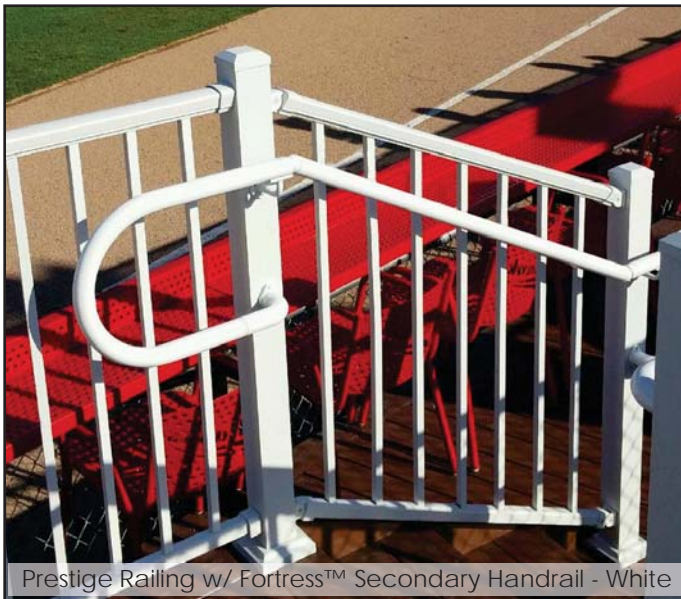

Prestige Railing w/ FortressTM Secondary Handrail - White



FortressTM Iron Railing w Cap Rail - Black Sand

ACTUAL FREIGHT CHARGES APPLY TO ALL SOLUTIONSTM RAIL ORDERS

1-1/2" SolutionsTM Aluminum Secondary Handrail - ADA Compliant



Aluminum Railing Systems ■ SOLUTIONSTM A310



Available in:

- Black
- Bronze
- White

8' Straight Handrail

Sold in any quantity.

1-1/2" x 8' Graspable handrail meets IRC, IBC requirements for secondary handrail system.

- Item # **301000** - Black
- Item # **301004** - Bronze
- Item # **301002** - White



Available in:

- Black
- Bronze
- White

Universal Quick Return Kit / Wall Mount

Sold in any quantity.

Connects handrail to any flat surface 3" or wider. Adjustable to any angle.

- Item # **301108** - Black
- Item # **301112** - Bronze
- Item # **301110** - White



Available in:

- Black
- Bronze
- White

Universal Mid-Rail Bracket Kit / Wall Mount

Sold in any quantity.

Mounts to any flat surface 3" or wider to provide support to rail. Adjustable to any angle.

- Item # **301090** - Black
- Item # **301094** - Bronze
- Item # **301092** - White



ACTUAL FREIGHT CHARGES APPLY TO ALL SOLUTIONSTM RAIL ORDERS



Available in:

- Black
- Bronze
- White

Handrail Connector Splice

Sold in any quantity.

Splices handrail components together for a rigid, sturdy connection.

- Item # **301030** - Black
- Item # **301034** - Bronze
- Item # **301032** - White



Available in:

- Black
- Bronze
- White

Wall Plate Bracket

Sold in any quantity.

Bracket is made to connect handrail to flat surfaces (2-1/4" or greater) where rail starts or ends at a vertical face. For level installations only.

- Item # **301120** - Black
- Item # **301124** - Bronze
- Item # **301122** - White

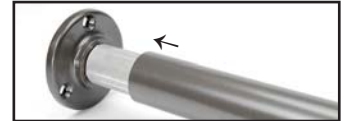

Available in:

- Black
- Bronze
- White

90 Degree Elbow - Outside Corner

Sold in any quantity.

Joins 1-1/2" rail for outside corner connection.

- Item # **301084** - Black
- Item # **301088** - Bronze
- Item # **301086** - White

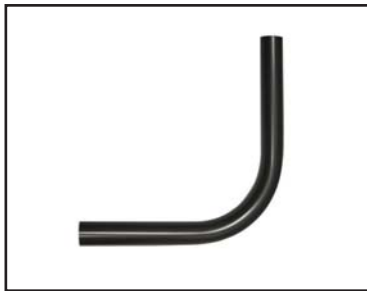

Available in:

- Black
- Bronze
- White

90 Degree Angle Rail - Inside Corner

Sold in any quantity.

Large 90 degree rail for inside corner applications. Requires rail connector splice at each end. (Sold Separately)

- Item # **301066** - Black
- Item # **301070** - Bronze
- Item # **301068** - White



Available in:

- Black
- Bronze
- White

6" Inside Corner Mounting Bracket

Sold in any quantity.

For secondary handrail 90 degree inside corner turns.

- Item # **301006** - Black
- Item # **301010** - Bronze
- Item # **301008** - White

ACTUAL FREIGHT CHARGES APPLY TO ALL SOLUTIONS™ RAIL ORDERS



Available in:

- Black
- Bronze
- White

5 Degree Angle Rail

Sold in any quantity.

Transitions handrail from a level run to a 5 degree ramp application. Requires rail connector splice at each end. (Sold Separately)

- Item # **301048** - Black
- Item # **301052** - Bronze
- Item # **301050** - White



Available in:

- Black
- Bronze
- White

32 Degree Angle Rail

Sold in any quantity.

Transitions handrail from a level run to a 32 degree stair run. Requires rail connector splice at each end. (Sold Separately)

- Item # **301054** - Black
- Item # **301058** - Bronze
- Item # **301056** - White



Available in:

- Black
- Bronze
- White

Universal Angle Rail Connector

Sold in any quantity.

Universal connector for two sections of hand rail at non-typical angles. Cut rails to proper angle and insert universal connector. Includes two splices and color match screws.

- Item # **301036** - Black
- Item # **301040** - Bronze
- Item # **301038** - White

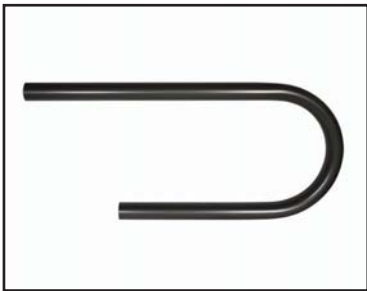

Available in:

- Black
- Bronze
- White

P-Loop Return Angle

Sold in any quantity.

ADA compliant for Handicap rail system regulations. Mounts to end post of ramps / stairs. Requires additional rail connector splice, mid-rail bracket, and quick return bracket for proper installation.

- Item # **301024** - Black
- Item # **301028** - Bronze
- Item # **301026** - White



Available in:

- Black
- Bronze
- White

End Cap

Sold in any quantity.

For capping 1-1/2" aluminum rail ends.

- Item # **301072** - Black
- Item # **301076** - Bronze
- Item # **301074** - White

ACTUAL FREIGHT CHARGES APPLY TO ALL SOLUTIONSTM RAIL ORDERS



Available in:

- Black
- Bronze
- White

Spacer Tube

Sold in any quantity.

Extends the length of any bracket from the post an additional 2-3/4".
Requires longer 3/8" bolt.

- Item # **301042** - Black
- Item # **301046** - Bronze
- Item # **301044** - White



Available in:

- Black
- Bronze
- White

Solutions Touch-Up Paint Pen

Sold in any quantity.

Paint pen used to touch up rails during and after installation.

Touch-Up Paint Pen

- Item #: **307320** - Black
- Item #: **307322** - Bronze
- Item #: **307324** - White



Available in:

- Black
- Bronze
- White

Solutions Screw Packs

6 / pack

#8 x 3/4" Self drilling, square drive screw for SolutionsTM aluminum railing.

- Item #: **302312** - Black
- Item #: **302311** - Bronze
- Item #: **302310** - White

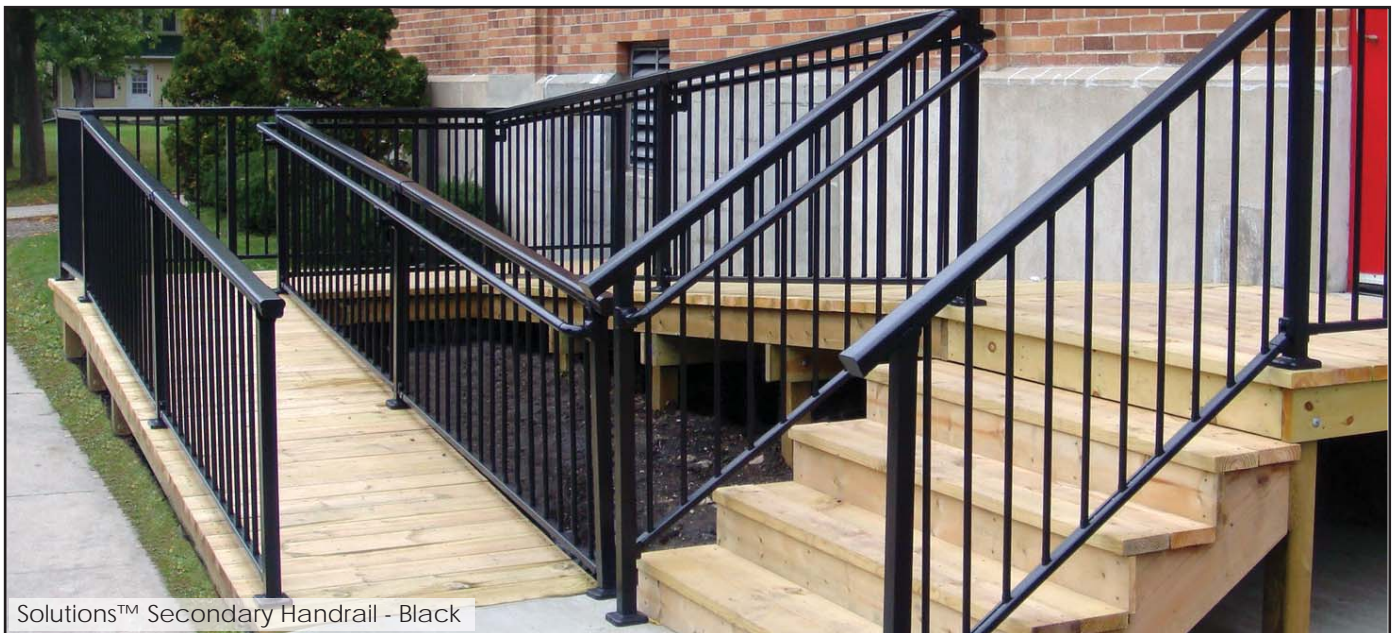

SolutionsTM Secondary Handrail - Black

ADITM

CABLE RAILING FOR WOOD



DekPro InvisiCable™
Cable Rail for Wood

pg 118 - 119

ADI™ Cable Railing System
by RailFX™

pg 120 - 131

DekPro InvisiCable™



Cable Railing for Wood Systems

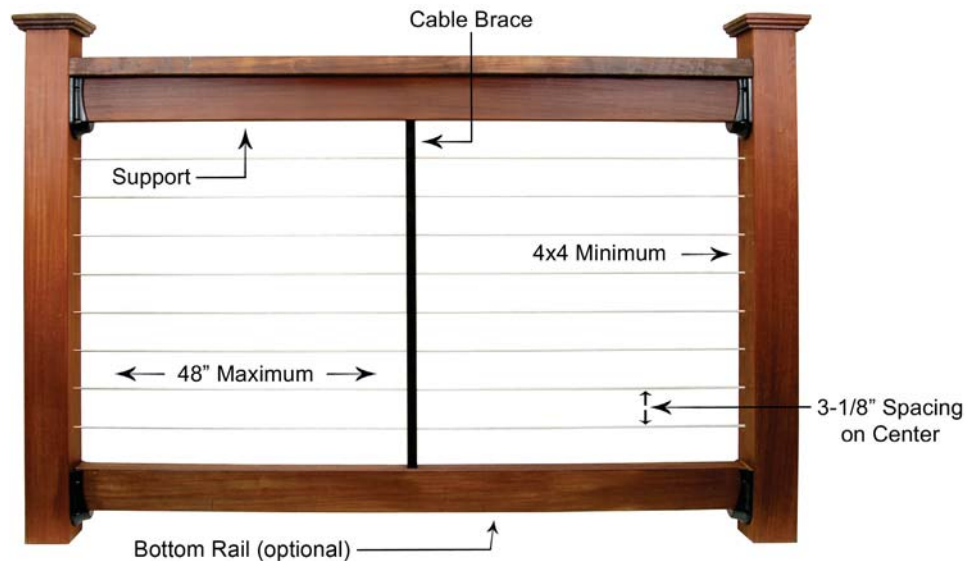

A simple, affordable cable railing option for the value conscious consumer that wants the look of cable but at a lower cost. Proudly made in the USA of 316 marine-grade stainless steel components and cable.

Kit includes 1 run of cable with 2.75" broached threaded tensioner, Pull-Lock fitting, two end caps, washers and brass Nylock hex nut. Kits are field trimmable to the proper length and come in 5' increments to 30' then 40' and 50'.

Don't confuse this kit with a competitors – we include **BOTH** end caps in each kit!

Perfect for interior and exterior use – decks, docks, balconies and stairways utilizing wood or solid composite posts. Fittings are concealed in the post creating a clean, almost invisible infill. Holes are drilled straight through the post and no angled holes or beveled washers are required.

Backed by ADI™ and DekPro™ Manufacturing with a 10 Year Warranty

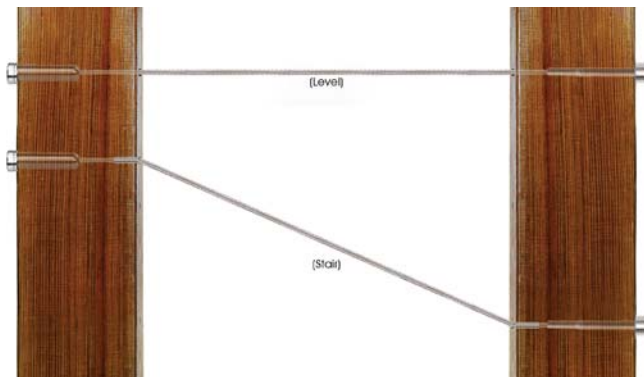

For level runs:

- Threaded Tensioner to Pull-Lock®.

For stairs, pitched runs:

- Threaded Tensioner to Pull-Lock® with 3/4" Post Protector Sleeve



Wood Rail w/ InvisiCableTM

DekPro InvisiCableTM for Wood



InvisiCableTM Kit for Wood

Sold in kits.

Cable railing kit made in USA from 1/8" high quality 316 grade stainless steel. Includes 1 strand of cable with 2.75" threaded stud on one end, Pull-LockTM fitting, washers, nut and 2 end caps.

- Item #: IC05 - 5' Cable Kit
- Item #: IC10 - 10' Cable Kit
- Item #: IC15 - 15' Cable Kit
- Item #: IC20 - 20' Cable Kit
- Item #: IC25 - 25' Cable Kit
- Item #: IC30 - 30' Cable Kit
- Item #: IC40 - 40' Cable Kit
- Item #: IC50 - 50' Cable Kit



THREADED STUD WITH
CAP, NUT AND WASHER



PULL-LOCKTM LAG

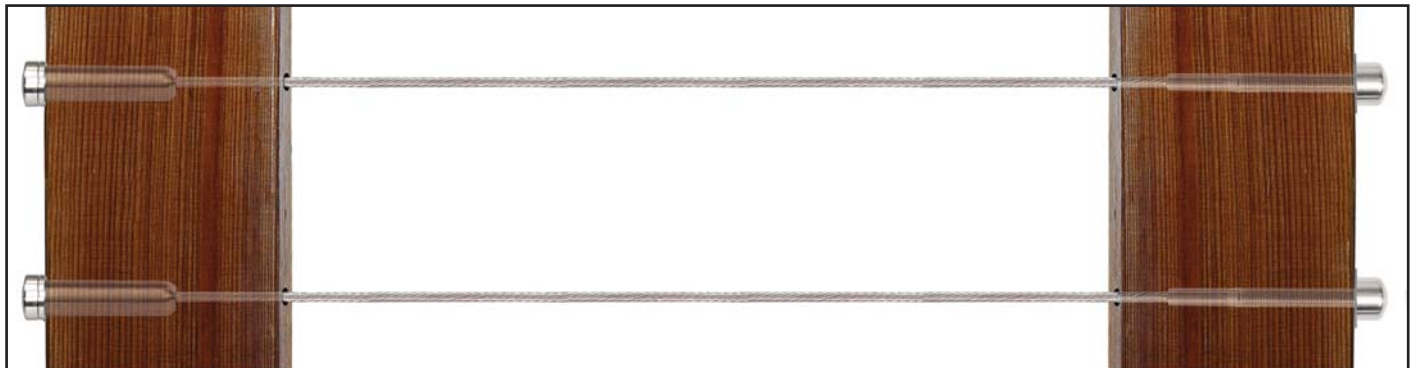

Cable Railing Overview

Framework for Cable Railing

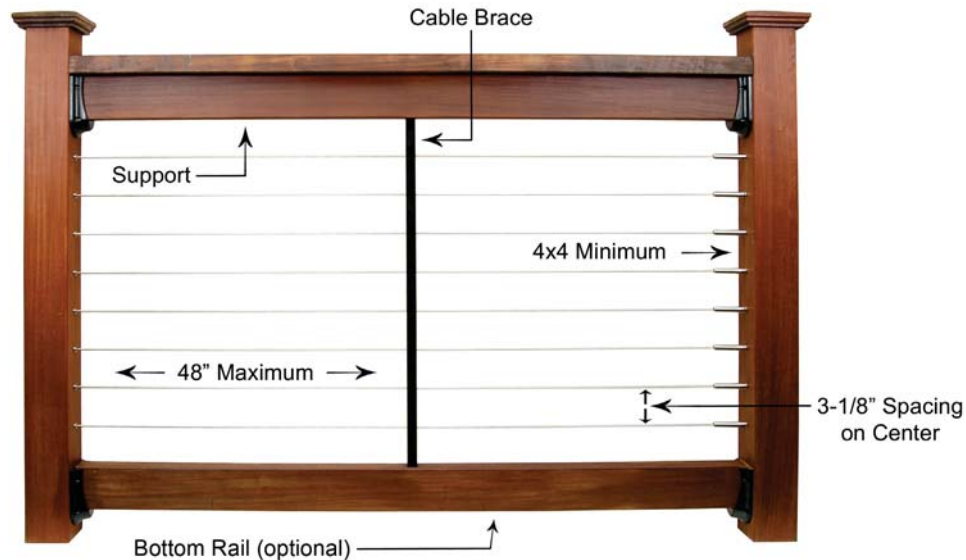

Guidelines for proper installation of the ADI™ cable railing system by RailFX™

- Use minimum 4x4 wood posts.
- Top rail is **required** to support posts. (Bottom rail is optional)
- Cables to be spaced at 3-1/8" on center.
- Cable must be supported every 48" to keep the cable from deflecting over 4" to pass code.
- Cables are to be tensioned to **225 lbs** of tension minimum.
- 36" Rail height typically uses 10 runs of cable, 42" rail height typically uses 12 runs of cable.
- Lag style cable fittings are required for cable being used with sleeved posts.
- If two posts are used on a corner of the deck, the cable can run through the corner by making a 45 degree turn through the posts with the use of post protector tubes.

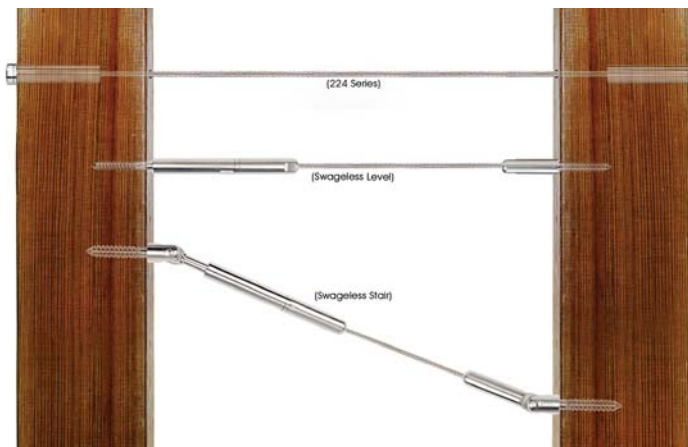

For level runs:

224 Series (outside to outside)
2-3/8" Invisiware® Receiver
to Pull-Lock®.

FlexFX - Level Cable Fittings
Lag style, Swageless Push-lock fittings.
Level Tensioner & Non-Tensioner

For stairs, pitched runs:

FlexFX - Stair Cable Fittings
Lag style, Swageless Push-lock fittings.
Stair Tensioner & Non-Tensioner



Wood Rail w/ Cable

Cable Railing Kits for Wood - Level



224 SERIES



INVISIWARE[®] RECEIVER



PULL-LOCK[™] END FITTING



Recommended Drill Bit

Outside of Post to Outside of Post Rail Kit - Wood Post

Sold in kits.

Cable railing kit made in USA from 1/8" high quality 316 grade stainless steel. Includes 1 strand of cable with one swaged end, applicable washers, Invisiware[®] receiver, Pull-Lock[™] end fitting and end cap. Minimum of 3" clearance between end post and structure is required.

Individual Cable Kits

- Item #: 22405 - 5' Cable Kit
- Item #: 22410 - 10' Cable Kit
- Item #: 22415 - 15' Cable Kit
- Item #: 22420 - 20' Cable Kit
- Item #: 22425 - 25' Cable Kit
- Item #: 22430 - 30' Cable Kit
- Item #: 22440 - 40' Cable Kit
- Item #: 22450 - 50' Cable Kit
- Item #: 22460 - 60' Cable Kit
- Item #: 22470 - 70' Cable Kit



10 Pack Cable Contractor Packs

Cable contractor packs include 10 - cables with one swaged end, 10 - Invisiware[®] receivers, 10 - Pull-Lock[™] end fittings w/ end caps and applicable washers.

- Item #: 22405-10 - 5' Cable Kits
- Item #: 22410-10 - 10' Cable Kits
- Item #: 22415-10 - 15' Cable Kits
- Item #: 22420-10 - 20' Cable Kits
- Item #: 22425-10 - 25' Cable Kits
- Item #: 22430-10 - 30' Cable Kits



Item #: CSD316 - Step Drill Bit to make 29/64" hole for fitting and 3/16" hole for cable.

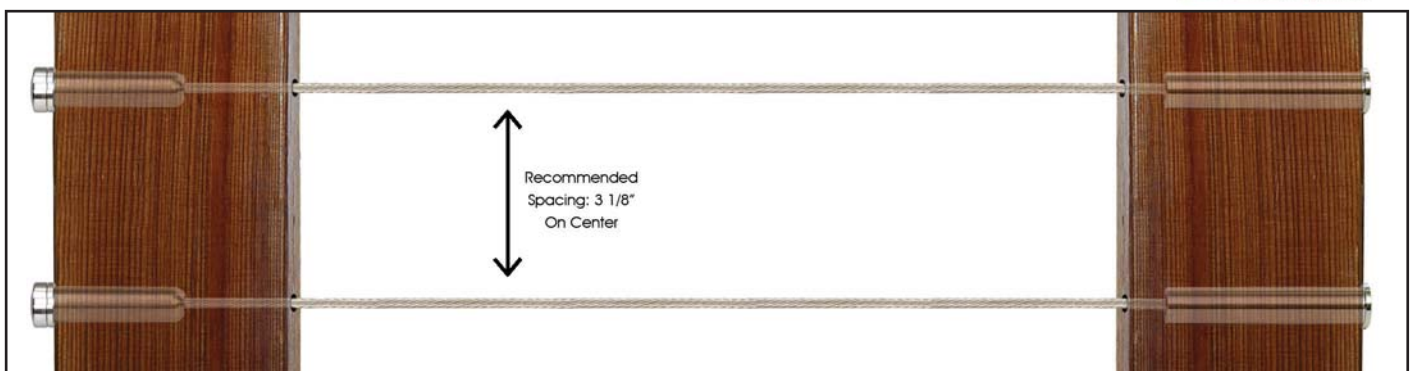



Wood Rail w/ FlexFXTM Cable

FlexFXTM Cable Railing for Wood - Level



FOR WOOD

FlexFXTM - Cable Fittings for Wood

Sold in any quantity.

Cable railing and fittings made in USA from high quality 316 grade stainless steel. Designed to work for wood posts. Pre-drill wood post using 7/32" drill bit.

Level Non-Tensioner Fittings

Item #: RFXWLN1/8 - 1/8" Fitting
Item #: RFXWLN1/8-10 - 1/8" Fitting (10 Pack)

Item #: RFXWLN3/16 - 3/16" Fitting

NON-TENSIONER



Level Tensioner Fittings

Item #: RFXWLT1/8 - 1/8" Fitting
Item #: RFXWLT1/8-10 - 1/8" Fitting (10 Pack)

Item #: RFXWLT3/16 - 3/16" Fitting

TENSIONER



Made in USA

Bulk Cable

Item #: RFXCABLE100 - 100' Spool of 1/8" Cable
Item #: RFXCABLE500 - 500' Spool of 1/8" Cable

Item #: RFXCABLE100-6 - 100' Spool of 3/16" Cable
Item #: RFXCABLE500-6 - 500' Spool of 3/16" Cable



Fitting Dimensions available for reference on page 130

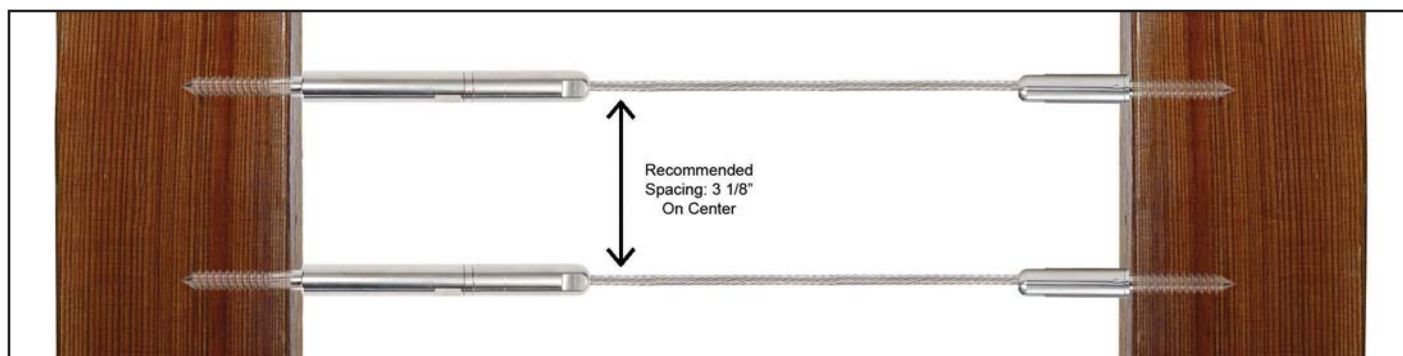

Recommended Spacing: 3 1/8" On Center



Wood Rail w/ FlexFXTM Cable

FlexFXTM Cable Railing for Wood - Stair



FOR WOOD



Fitting Dimensions available for reference on page 130

FlexFXTM - Cable Fittings for Wood

Sold in any quantity.

Cable railing and fittings made in USA from high quality 316 grade stainless steel. Designed to work for wood posts. Pre-drill wood post using 7/32" drill bit.

Stair Non-Tensioner Fittings

- Item #: RFXWSN1/8 - 1/8" Fitting
- Item #: RFXWSN1/8-10 - 1/8" Fitting (10 Pack)
- Item #: RFXWSN3/16 - 3/16" Fitting

NON-TENSIONER



Stair Tensioner Fittings

- Item #: RFXWST1/8 - 1/8" Fitting
- Item #: RFXWST1/8-10 - 1/8" Fitting (10 Pack)
- Item #: RFXWST3/16 - 3/16" Fitting

TENSIONER



Bulk Cable

- Item #: RFXCABLE100 - 100' Spool of 1/8" Cable
- Item #: RFXCABLE500 - 500' Spool of 1/8" Cable

- Item #: RFXCABLE100-6 - 100' Spool of 3/16" Cable
- Item #: RFXCABLE500-6 - 500' Spool of 3/16" Cable

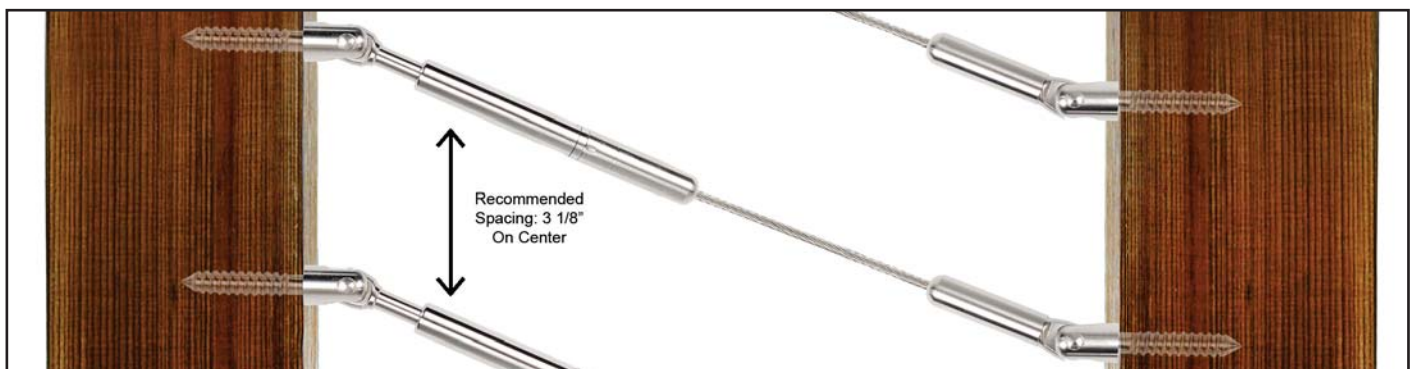



Composite Sleeved Rail w/ FlexFXTM Cable

FlexFXTM Cable Railing for Composite Sleeve - Level



**FOR
COMPOSITE
SLEEVES**

1" Longer Lag



*Fitting Dimensions available for
reference on page 130*

FlexFXTM XL - Cable Fittings for Composite Sleeves

Sold in any quantity.

Cable railing and fittings made in USA from high quality 316 grade stainless steel. Designed to work for composite sleeved wood posts. Pre-drill using 7/32" drill bit.

XL - Level Non-Tensioner Fittings

- Item #: RFXWLN1/8XL - 1/8" Fitting
- Item #: RFXWLN1/8XL-10 - 1/8" Fitting (10 Pack)
- Item #: RFXWLN3/16XL - 3/16" Fitting

XL - NON-TENSIONER



XL - Level Tensioner Fittings

- Item #: RFXWLT1/8XL - 1/8" Fitting
- Item #: RFXWLT1/8XL-10 - 1/8" Fitting (10 Pack)
- Item #: RFXWLT3/16XL - 3/16" Fitting

XL - TENSIONER



Bulk Cable

- Item #: RFXCABLE100 - 100' Spool of 1/8" Cable
- Item #: RFXCABLE500 - 500' Spool of 1/8" Cable

- Item #: RFXCABLE100-6 - 100' Spool of 3/16" Cable
- Item #: RFXCABLE500-6 - 500' Spool of 3/16" Cable

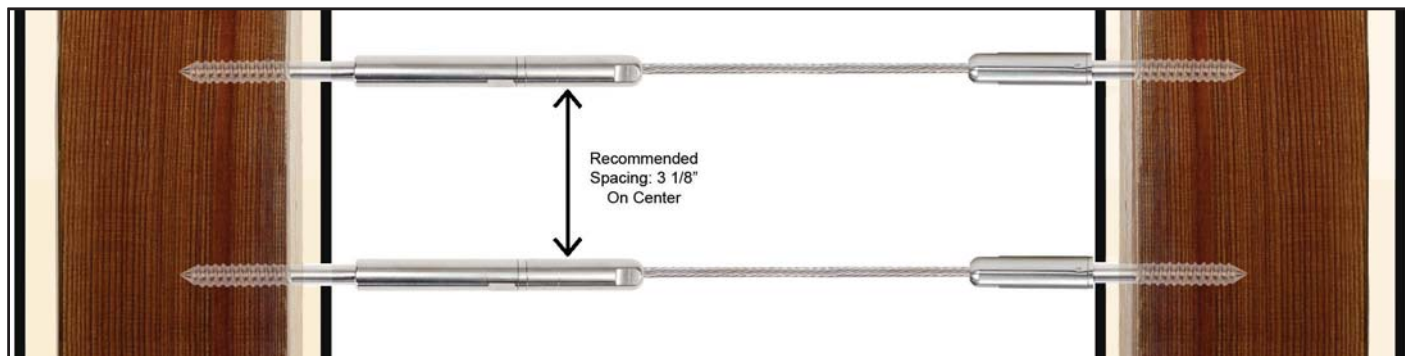

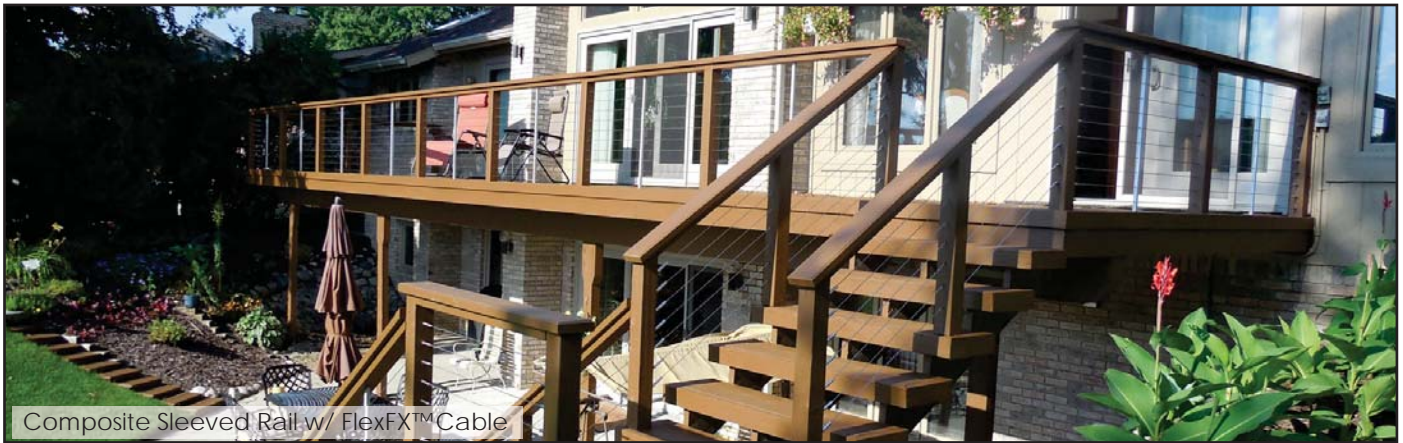

Composite Sleeved Rail w/ FlexFXTM Cable

FlexFXTM Cable Railing for Composite Sleeve - Stair



**FOR
COMPOSITE
SLEEVES**
1" Longer Lag



*Fitting Dimensions available for
reference on page 130*

FlexFXTM XL - Cable Fittings for Composite Sleeves

Sold in any quantity.

Cable railing and fittings made in USA from high quality 316 grade stainless steel. Designed to work for composite sleeved wood posts. Pre-drill using 7/32" drill bit.

XL - Stair Non-Tensioner Fittings

- Item #: RFXWSN1/8XL - 1/8" Fitting
- Item #: RFXWSN1/8XL-10 - 1/8" Fitting (10 Pack)
- Item #: RFXWSN3/16 - 3/16" Fitting



XL - NON-TENSIONER

XL - Stair Tensioner Fittings

- Item #: RFXWST1/8XL - 1/8" Fitting
- Item #: RFXWST1/8XL-10 - 1/8" Fitting (10 Pack)
- Item #: RFXWST3/16XL - 3/16" Fitting



XL - TENSIONER

Bulk Cable

- Item #: RFXCABLE100 - 100' Spool of 1/8" Cable
- Item #: RFXCABLE500 - 500' Spool of 1/8" Cable

- Item #: RFXCABLE100-6 - 100' Spool of 3/16" Cable
- Item #: RFXCABLE500-6 - 500' Spool of 3/16" Cable

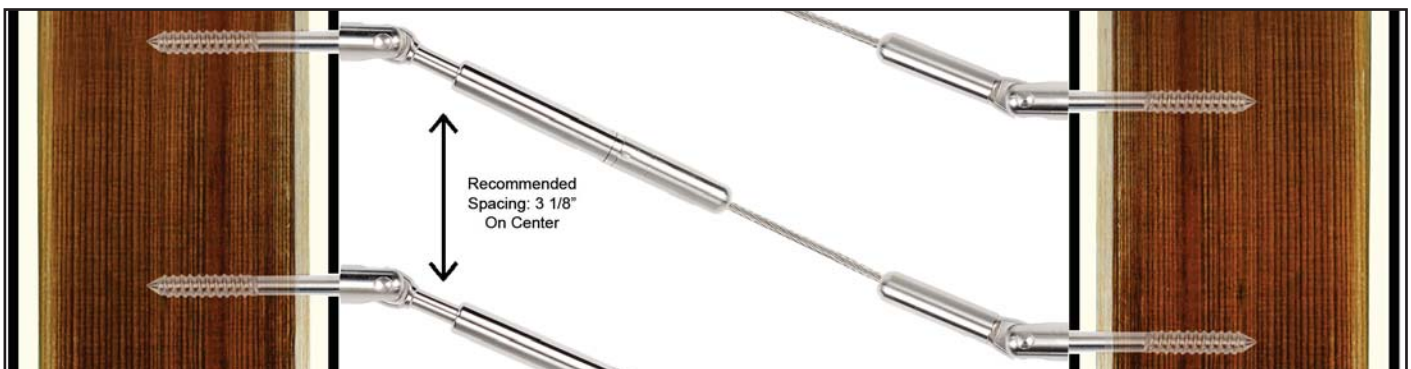

Cable Braces

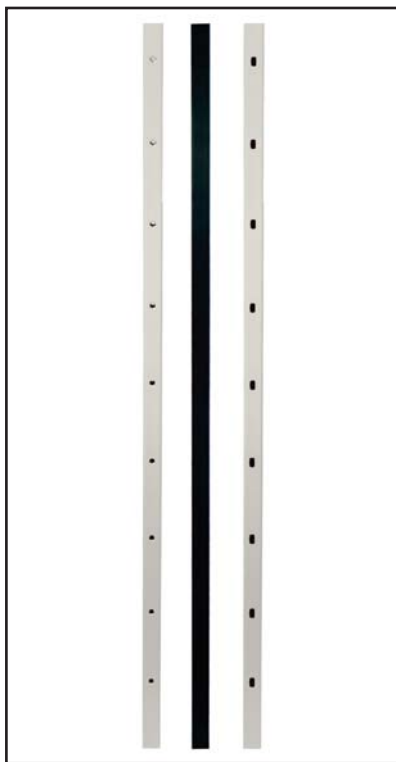

Available in:

Black

Anodized

Cable Brace for Level and Stair (1/8" Cable Only)

Sold in any quantity.

3/4" Aluminum cable brace is available pre-drilled with 12 holes at 3-1/8" spacing on center for level and stair runs. Available undrilled for unique installations. Trimmable to fit any rail height. Cable braces are used between newel posts that are greater than 48" apart to keep cables from deflecting over 4". Connectors and stainless steel screws included.

Pre-Drilled 42" Level

Item # CB42BLAL13/P - Black
Item # CB42ANAL13/P - Anodized

Pre-Drilled 50" Stair

Item # CB50BL12/P - Black
Item # CB50AN12/P - Anodized

UnDrilled 42" Level or Stair

Item # CB42BLAL/P - Black
Item # CB42ANAL/P - Anodized



Pictures do not reflect full length of cable brace



FlexFX Cables w/ Painted Wood Rail

Cable Railing Tools



Post Protector Tubes

Sold in packs of 10.

Stainless Steel protector tubes are inserted into wood post where cable enters/exits at an angle to prevent cable from biting into the wood. 1/4" diameter with 3/8" tapered end.

Item #: ICTUBE/10 - 3/4" Length - 10 pack
Item #: CSTUBE6 - 1-1/2" Length - Individual

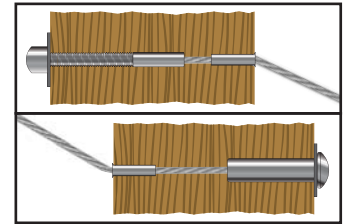

Cable Cutters

Sold in any quantity.

Cable cutter designed for clean, burr free cutting of 1/8" stainless steel cable. Required for use with FlexFXTM lag style fittings.

Item #: RFXC7HIT - for 1/8" Cable
Item #: RFXC9 - for 3/16" Cable



Push Lock Release Key

Sold in any quantity.

Release key allows the release of an untensioned cable from Pull-LockTM and FlexFXTM fittings. Also used to release fittings to aid installation.

Item #: RFXPLKEY/R



Cable Gripping Pliers

Sold in any quantity.

Used to securely grip cable to avoid winding during installation which eliminates the most common issue of cables losing tension. Cable gripping pliers are recommended for professional installers.

Item #: RFXPLIERS





Cable Cut Off Kit

Sold in any quantity.

Used to cut cable flush to the end of Pull-LockTM fittings and excess threads from stud type tensioners. Includes mandrel and 2 cut off wheels.

Item #: RFXCUTOFFKIT/R

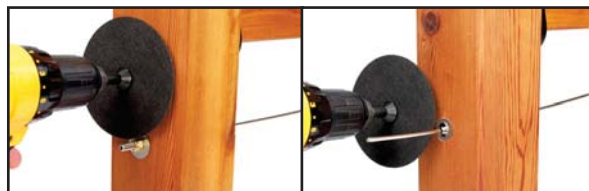

Push-Lock Lag Driver

Sold in any quantity.

Huge time saving tool makes installing the FlexFXTM non-tensioning lag fitting quick and easy. Used with WLN series cable fittings.

Item #: RFXDRIVER/R



ADITM Cable Railing Basic Install Kit

Sold as a Kit.

Installation tools for basic cable railing installations. Kit includes 29/64", 7/32", 9/32", and 5/32" diameter high quality Norseman drill bits, 2 cut off wheels w/ mandrel, push lock release tool, 3/16" heavy duty hex wrench, 1/8" hex wrench, and 7/16" wrench

Item #: ADICRKIT



FlexFXTM Cable Railing Install Kit

Sold as a Kit.

Installation tools for FlexFXTM Swageless lag style cable railing. Kit includes 7/32", 1/4" and 5/32" diameter drill bits, 2 push lock release keys, cable gripping tool, Push-Lock lag driver, 5/32" allen wrench, and 2 - 3" combo wrenches.

Item #: RFXINSKIT





Cable Lacing Needle (1/8" Cable Only)

Sold in any quantity.

Used to pass 1/8" cable through posts without snagging / fraying during installation. Fits 3/16" diameter hole or larger.

Item # RFXNEEDLE - Cable Lacing Needle



QuickGrip Cable Tool

Sold in Packs of 2.

Used to grip cable to avoid winding during installation which eliminates the most common issue of cables losing tension. Tool is recommended for single installations.

Item #: RFXGRIPPER



Cable Railing Drill Bits

Sold in any quantity.

For wood, to make 29/64" hole for Invisiware receiver / Pull-Lock fittings. Step drill bit creates a 3/16" hole for the cable using a single drill bit.

Item #: CSD316 - ADI Step Drill Bit (29/64" to 3/16")

Item #: 29/64DRILL - 29/64" Drill Bit

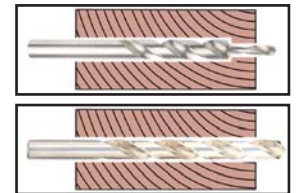

EZ-Clean Metal Cleaner / Protectant

Sold in any quantity.

Cleaner / Protector dissolves minor corrosion and leaves a protective coating that lasts for months. Includes 8 oz. rust and stain remover and 4 oz. bottle of protectant.

Item #: RFXEPCLEAN



Cable Tension Gauge

Sold in any quantity.

Used to determine proper tension of cables.

Item # RFXPTCR - Tension Gauge

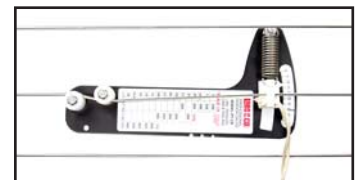

FlexFX[™] Cable Fitting Reference Guide

FlexFX[™] Cable Fittings for Wood

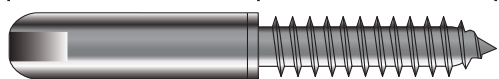

Level - Non-Tensioner for Wood (RFXWLN1/8)

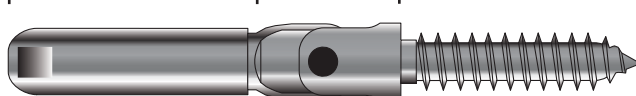
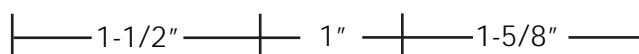

Stair - Non-Tensioner for Wood (RFXWSN1/8)

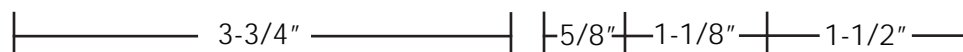

Level - Tensioner for Wood (RFXWLT1/8)



Stair - Tensioner for Wood (RFXWST1/8)

FlexFX[™]-XL Cable Fittings for Composite Sleeves

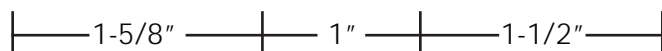

Level - Non-Tensioner for Composite (RFXWLN1/8XL)

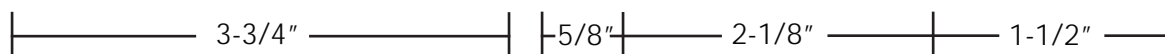

Level - Tensioner for Composite (RFXWLT1/8XL)

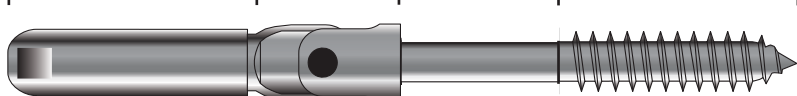
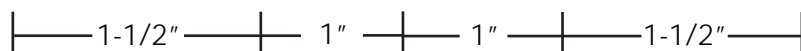

Stair - Non-Tensioner for Composite (RFXWSN1/8XL)

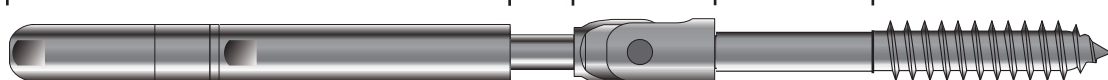

Stair - Tensioner for Composite (RFXWST1/8XL)



FlexFXTM-XL Cables w/ Composite Sleeved Rail



FlexFXTM Cables w/ Wood Rail



DekProTM InvisiCable w/ Painted Wood Railing



224 Series Cables w/ Wood Rail

ADITM

CABLE RAILING FOR METAL



RailFX™

Aluminum Railing
and Cable System

pg 134 - 157

Fortress™

Vertical Cable Railing
Horizontal Cable Railing

pg 158 - 163

pg 164 - 169

DekPro™ Prestige

Textured Aluminum Rail for Cable

pg 170 - 173

RailFX™ FlexFX for Metal

Cable for Metal Posts

pg 174 - 177

RailFX™ Railing System Overview

RailFX™ Aluminum Rail with Cable

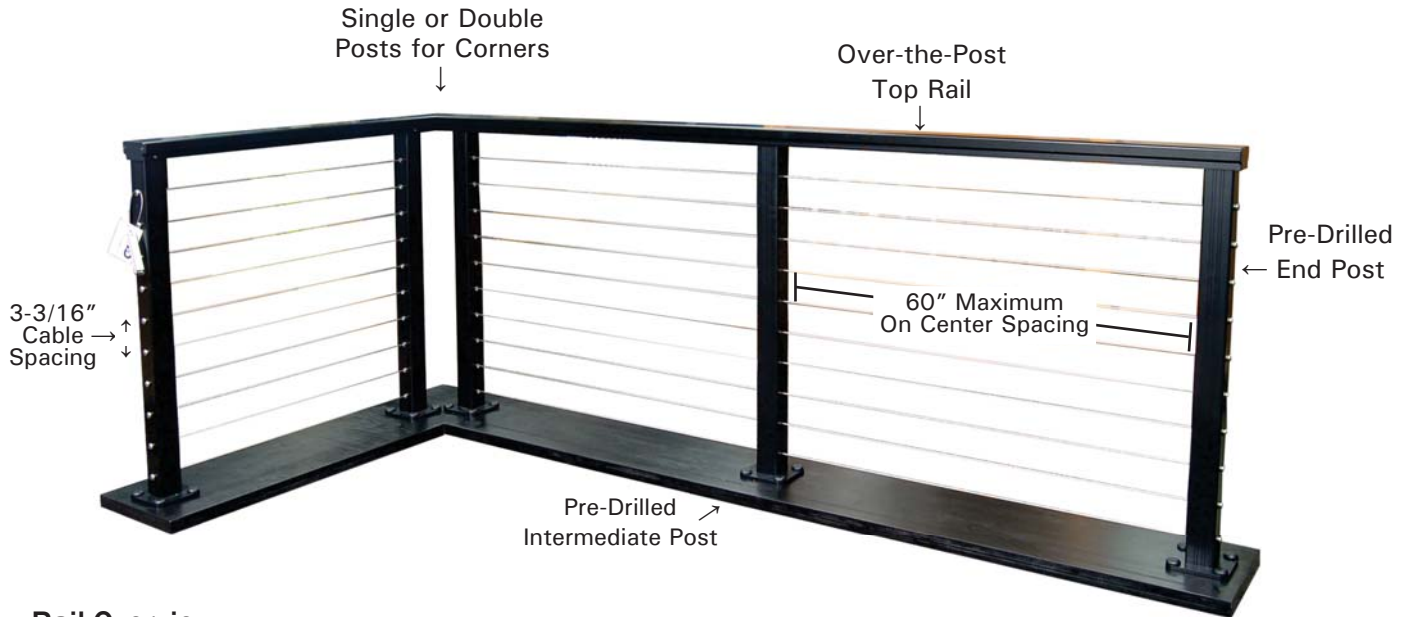

Rail Overview

Manufactured in the USA using aircraft grade aluminum, RailFX™ Aluminum Rail and Cable System has been designed, engineered and tested specifically for use with cable and is approved in all 50 states. The aluminum framework and stainless steel cable allows for railings to be lightweight, while still retaining exceptional durability. Railings will not rust, rot, warp, or split and require minimal user maintenance.

Rail Guidelines

To comply with engineering and testing **posts must be spaced no more than 60" on center**. Cables are spaced at 3-3/16" on center to keep the cable from deflecting beyond 4" to meet code. Single or double posts can be used to create a 90 degree corner for surface mount posts. Two corner posts are required for fascia mount applications. Cable can either terminate at the corner or run continuously through a single corner. Top rail is required for all installations.

Posts

RailFX™ posts for level and stair railings are all predrilled and ready for cable installation. Stairs posts do not come with base plates attached so posts can be placed and mounted where desired for maximizing installation flexibility. All posts are available for surface mount or fascia mount and available for 36" and/or 42" rail heights.

Top Rails

There are 3 styles of top rail that RailFX™ railing utilizes:

Series 200 is a contemporary flat top rail most often used for level applications. Can be used for stairs with the addition of a secondary handrail system.

Series 250 is a square profile that qualifies as a graspable rail and is most commonly used for stairs.

Series 400 is a flat top rail that is designed to accept a wood or composite cap rail.

Available Colors:

Colors shown are approximate representation



Black



Bronze



White



Silver

Features AAMA 2605 Powder Coat Finish

RailFX™ - Aluminum Rail System for Cable Railing



RailFX™ Aluminum Rail and Cable - Silver - Series 200 Top Rail

Cable Railing Kits for Aluminum Rail



224 SERIES



INVISIWARE® RECEIVER



PULL-LOCK™ END FITTING



Made in USA

Outside of Post to Outside of Post Rail Kit - Aluminum Rail System for 2-3/8" Posts

Sold in kits.

Cable railing kit, made in USA from 1/8" high quality 316 grade stainless steel. Includes 1 strand of cable with one swaged end, applicable washers, Invisiware® receiver, Pull-Lock™ end fitting and end cap. Minimum 3" clearance between end post and structure is required.

Individual Cable Kits

- Item #: 22405 - 5' Cable Kit
- Item #: 22410 - 10' Cable Kit
- Item #: 22415 - 15' Cable Kit
- Item #: 22420 - 20' Cable Kit
- Item #: 22425 - 25' Cable Kit
- Item #: 22430 - 30' Cable Kit
- Item #: 22440 - 40' Cable Kit
- Item #: 22450 - 50' Cable Kit
- Item #: 22460 - 60' Cable Kit
- Item #: 22470 - 70' Cable Kit



10 Pack Cable Contractor Packs

- Item #: 22405-10 - 5' Cable Kits
- Item #: 22410-10 - 10' Cable Kits
- Item #: 22415-10 - 15' Cable Kits
- Item #: 22420-10 - 20' Cable Kits
- Item #: 22425-10 - 25' Cable Kits
- Item #: 22430-10 - 30' Cable Kits

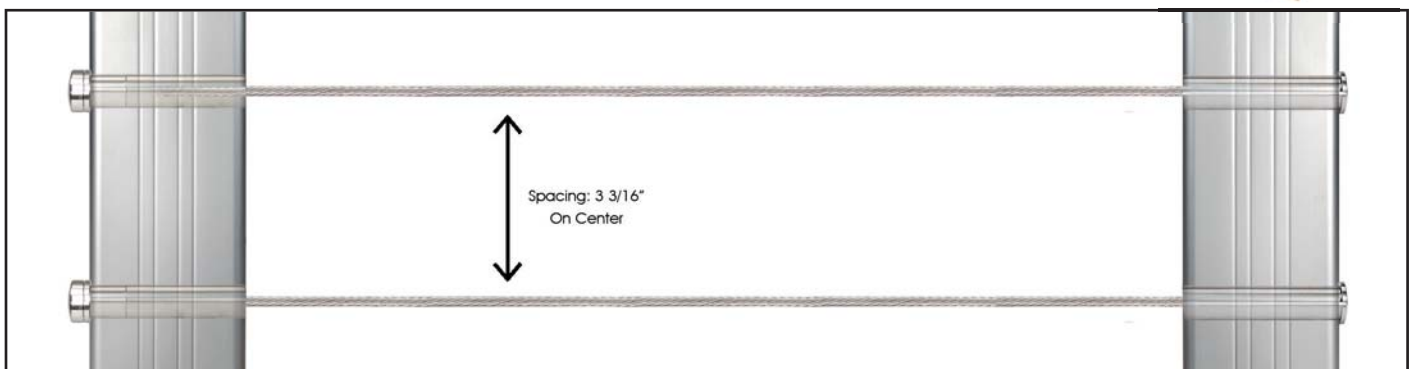

ACTUAL FREIGHT CHARGES WILL BE APPLIED TO ALL RAILFX™ ORDERS

RailFX™ Series 200 Top Rail



Available in:

Black

Bronze

White

Silver

Series 200 Top Rail

Sold in any quantity.

3-1/2" x 1-7/8" x 94" Series 200 aluminum top rail. Join multiple rails together with splices to achieve any length required. Field trimmable with carbide blade. Includes bottom finishing plate for clean look.

End plate sold separately.

94" Top Rail (3-1/2" x 1-7/8" x 94")

Item #: FXTR200BLKKIT8 - Black

Item #: FXTR200BRZKIT8 - Bronze

Item #: FXTR200WHTKIT8 - White

Item #: FXTR200SILKIT8 - Silver

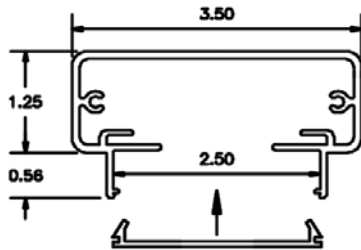
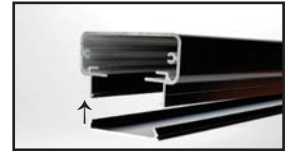

Available in:

Walnut Woodgrain

Series 200 Top Rail - Walnut Woodgrain

Sold in any quantity.

3-1/2" x 1-7/8" x 94" Series 200 aluminum top rail with powder coated woodgrain finish. Offers the look of Walnut / IPE without the maintenance. Join multiple rails together with splices to achieve any length required. Field trimmable with carbide blade. Includes bottom finishing plate for clean look. **End plate sold separately.**

Item #: FXTR200WALKIT8 - 94" Length, Walnut Woodgrain



Available in:

Black

Bronze

White

Silver

Walnut Woodgrain

Series 200 Top Rail End Plate

Sold in any quantity.

Aluminum end plate required to cap series 200 top rail ends for a finished look. Includes 2 color matched screws.

Item #: FXEP200BLK - Black

Item #: FXEP200BRZ - Bronze

Item #: FXEP200WHT - White

Item #: FXEP200SIL - Silver

Item #: FXEP200WAL - Walnut Woodgrain



ACTUAL FREIGHT CHARGES WILL BE APPLIED TO ALL RAILFX™ ORDERS



Available in:

Black

Bronze

White

Silver



Series 200 End Plate Bracket

Sold in any quantity.

Aluminum end plate bracket used to connect series 200 top rails perpendicularly. Used at the top of the stair where the level and stair rails meet at 90 degrees. Allows for single corner post use at top of stairs. Includes 2 color matched screws.

Item #: FXEPB200BLK - Black
Item #: FXEPB200BRZ - Bronze
Item #: FXEPB200WHT - White
Item #: FXEPB200SIL - Silver



Scenario # 1 - Single Corner Stair Post (Install method #1)



Scenario # 2 - 90 Return to Stair (Install method #2)



Install Method #1



Install Method #2



ACTUAL FREIGHT CHARGES WILL BE APPLIED TO ALL RAILFX™ ORDERS

RailFX™ Series 200 Rail Splices



Available in:
Aluminum

Straight Splice - 200 Series

Sold in any quantity.

9" long splice joins straight sections of series 200 top rail to make any length run. Splices and be used between posts. Installs using 8 - #10 x 3/4" self-drilling screws (Not Included)

Item #: FXSPL200 - Straight Splice



Available in:
Aluminum

90 Degree Splice - 200 Series

Sold in any quantity.

Splices top rails to make a 90 degree angle for series 200 top rail. Requires miter cutting of top rail. Installs using 8 - #10 x 3/4" self-drilling screws (Not Included)

Item #: FXSPL20090 - 90 Degree Splice



Available in:
Aluminum

135 Degree Splice - 200 Series

Sold in any quantity.

Splices top rails to make a 135 degree angle for series 200 top rail. Requires miter cutting of top rail. Installs using 8 - #10 x 3/4" self-drilling screws (Not Included)

Item #: FXSPL200135 - 135 Degree Splice



Available in:
Aluminum

Notched Splice for Stairs - 200 Series

Sold in any quantity.

For continuous level to stair transition. Bends to accommodate any angle from 0° - 38°. Requires miter cutting of top rail. Installs using 8 - #10 x 3/4" self-drilling screws (Not Included)

Item #: FXSPLST - Notched Splice



ACTUAL FREIGHT CHARGES WILL BE APPLIED TO ALL RAILFXTM ORDERS



RailFXTM Aluminum Rail and Cable - Silver - Series 400 w/ Wood Cap Rail

RailFX Series 400 Top Rail



Available in:

Black

Bronze

White

Silver

Series 400 Top Rail for Wood Cap Rail

Sold in any quantity.

2-7/8" x 1-1/4" x 94" Series 400 aluminum rail cap for attaching wood/composite top rail. Field trimmable with carbide blade. Includes bottom finishing plate. Series 400 top rail is designed to allow for the attachment of a wood or composite cap rail. Cap rail **MUST add 1/2"** to overall rail height to reach required rail heights for both 36" and 42" rails.



94" Top Rail (2-7/8" x 1-1/4" x 94")

Item #: FXTR400BLK8KIT - Black
Item #: FXTR400BRZ8KIT - Bronze
Item #: FXTR400WHT8KIT - White
Item #: FXTR400SIL8KIT - Silver



*Wood cap rail not included

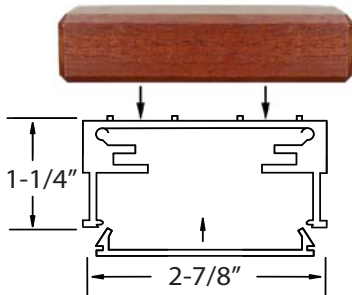

Available in:

Black

Bronze

White

Silver

Series 400 Top Rail End Plate

Sold in any quantity.

Aluminum end plate required to cap series 400 top rail ends for a finished look. Includes 2 color matched screws.

Item #: FXEP400BLK - Black
Item #: FXEP400BRZ - Bronze
Item #: FXEP400WHT - White
Item #: FXEP400SIL - Silver



ACTUAL FREIGHT CHARGES WILL BE APPLIED TO ALL RAILFX™ ORDERS



Available in:

Aluminum

Straight Splice - 400 Series

Sold in any quantity.

9" long splice joins straight sections of series 400 top rail to make any length run. Installs using 8 - #10 x 3/4" self-drilling screws (Not Included)

Item # FXSPL400LEVEL



Available in:

Aluminum

90 Degree Splice - 400 Series

Sold in any quantity.

Splices top rails to make a 90 degree corner for series 400 top rail. Requires miter cutting of top rail. Installs using 8 - #10 x 3/4" self-drilling screws (Not Included)

Item # FXSPL40090



Available in:

Aluminum

135 Degree Splice - 400 Series

Sold in any quantity.

Splices top rails to make a 135 degree angle for series 400 top rail. Requires miter cutting of top rail. Installs using 8 - #10 x 3/4" self-drilling screws (Not Included)

Item # FXSPL400135



Available in:

Aluminum

Stair Splice - 400 Series

Sold in any quantity.

For continuous level to stair transition. Bends to accommodate any angle from 0° - 38°. Requires miter cutting of top rail. Installs using 8 - #10 x 3/4" self-drilling screws (Not Included)

Item # FXSPL400STAIR



ACTUAL FREIGHT CHARGES WILL BE APPLIED TO ALL RAILFXTM ORDERS



RailFXTM Aluminum Rail and Cable - Black - Series 250 (Graspable Stair)

RailFXTM Series 250 Graspable Top Rail for Stair & Level Applications

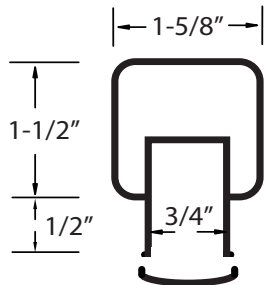

Available in:

- Black
- Bronze
- White
- Silver

Series 250 Top Rail for Stairs

Sold in any quantity.

2" x 1-5/8" x 94" Series 250 aluminum top rail. Qualifies as continuous graspable handrail when used with intermediate post fitting. Field trimmable with carbide blade. Includes bottom finishing plate for clean look. Requires IPF fitting for mounting over the post. **End plate sold separately.**



94" Top Rail (2" x 1-5/8" x 94")

- Item #: FXTR250BLK8KIT - Black
- Item #: FXTR250BRZ8KIT - Bronze
- Item #: FXTR250WHT8KIT - White
- Item #: FXTR250SIL8KIT - Silver



Available in:

- Black
- Bronze
- White
- Silver

Series 250 Top Rail End Plate

Sold in any quantity.

Aluminum end plate required to cap series 250 top rail ends for a finished look. Use adhesive to attach to rail.



- Item #: FXEP250BLK - Black
- Item #: FXEP250BRZ - Bronze
- Item #: FXEP250WHT - White
- Item #: FXEP250SIL - Silver



ACTUAL FREIGHT CHARGES WILL BE APPLIED TO ALL RAILFX™ ORDERS



Available in:

Black

Bronze

White

Silver

Intermediate Post Fitting (IPF)

Sold in any quantity.

Used on stair posts for over the post mounting style of series 250 top rail. Fitting attaches to the top of post and allows for top rail to be installed at any angle. Measures 3/4" W x 1-1/2" L x 2" H. Includes 2 ea. screws for post attachment.

Item #: FXIPFSETBLK - Black
Item #: FXIPFSETBRZ - Bronze
Item #: FXIPFSETWHT - White
Item #: FXIPFSETSIL - Silver

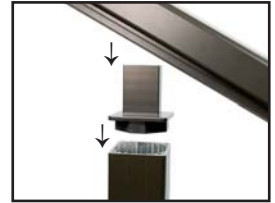

Available in:

Aluminum

Rail Connector Block

Sold in any quantity.

Used to terminate series 250 top rail into post. 12" connector block can be cut into smaller blocks at angle of the stair. It can also be used to splice series 250 top rail together. When splicing, use 8 color matched screws to secure in place (Not Included). Can be used for level and stair applications. Screws included.

Item #: FXRCB1 - 1" Connector Block - Level (2 Screws)

Item #: FXRCB12 - 12" Connector Block / Splice (6 Screws)

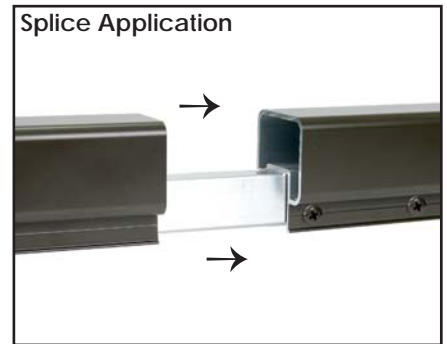

RailFX™ Silver - Series 250 (Graspable Stair)



RailFX™ Black - Series 250 (Graspable Stair)

ACTUAL FREIGHT CHARGES WILL BE APPLIED TO ALL RAILFXTM ORDERS

RailFX Top Post Plates to Attach Wood Cap Rail



Available in:

Black

Bronze

White

Silver

Level Top Plate

Sold in any quantity.

Plate mounts to the top of level posts to accommodate various top rails to be attached. Top rail must be structural and meet code requirements. Measures 3" x 5" x 3/8". Includes hardware to attach to post. Use T40 torx bit for installation.

Item #: FXTP3X5L2HBLK - Black
Item #: FXTP3X5L2HBRZ - Bronze
Item #: FXTP3X5L2HWHT - White
Item #: FXTP3X5L2HSIL - Silver



Available in:

Black

Bronze

White

Silver

Corner Top Plate

Sold in any quantity.

Plate mounts to the top of level corner posts to accommodate various top rails to be attached. Top rail must be structural and meet code requirements. Measures 5" x 5" x 3/8". Includes hardware to attach to post. Use T40 torx bit for installation.

Item #: FXTPCORNER2HBLK - Black
Item #: FXTPCORNER2HBRZ - Bronze
Item #: FXTPCORNER2HWHT - White
Item #: FXTPCORNER2HSIL - Silver



Available in:

Black

Bronze

White

Silver

Stair Top Plate

Sold in any quantity.

Plate mounts to the top of stair posts to accommodate various top rails to be attached. Top rail must be structural and meet code requirements. Measures 3" x 5" x 3/8". Includes hardware to attach to post. Use T40 torx bit for installation.

Item #: FXTP3X5S1HBLK - Black
Item #: FXTP3X5S1HBRZ - Bronze
Item #: FXTP3X5S1HWHT - White
Item #: FXTP3X5S1HSIL - Silver

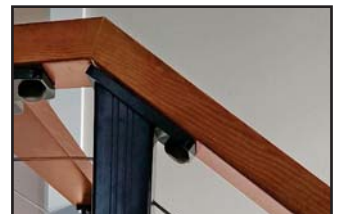

Available in:

Black

Bronze

White

Silver

Adjustable Top Plate

Sold in any quantity.

Adjustable plate mounts to the top of post to accommodate various top rails to be attached. Articulating plate can adjust up / down and pivot at angle. Can be used for level or stair applications. Top rail must be structural and meet code requirements. Includes hardware to attach to post.

Item #: FXIPFADJSETBLK - Black
Item #: FXIPFADJSETBRZ - Bronze
Item #: FXIPFADJSETWHT - White
Item #: FXIPFADJSETSIL - Silver



ACTUAL FREIGHT CHARGES WILL BE APPLIED TO ALL RAILFX™ ORDERS

RailFX™ Surface Mount Posts



Available in:

Black

Bronze

White

Silver

Surface Mount End Post - Pre-Drilled

Sold in any quantity.

2-3/8" Square surface mount post with 5" base plate. Base plate holes for fasteners are 3/8". Pre-drilled post is drilled at 3-3/16" on center spacing. 10 holes for 36" rail, 12 holes for 42" rail. Engineered to meet code with posts at 60" on center spacing. Includes 4 ea. bolt cap covers. **Fasteners for mounting base plate to deck sold separately.**

36" Rail Height (2-3/8" x 35")

Item #: FXCEP200BLK35KIT - Black
Item #: FXCEP200BRZ35KIT - Bronze
Item #: FXCEP200WHT35KIT - White
Item #: FXCEP200SIL35KIT - Silver

42" Rail Height (2-3/8" x 41")

Item #: FXCEP200BLK41KIT - Black
Item #: FXCEP200BRZ41KIT - Bronze
Item #: FXCEP200WHT41KIT - White
Item #: FXCEP200SIL41KIT - Silver

Base Plate Post Skirts are Available
See page 149

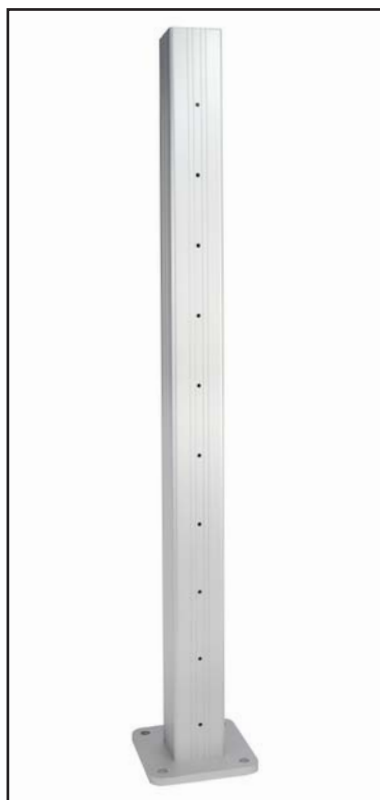

Available in:

Black

Bronze

White

Silver

Surface Mount Intermediate Post - Pre-Drilled

Sold in any quantity.

2-3/8" Square surface mount post with 5" base plate. Base plate holes for fasteners are 3/8". Pre-drilled post is drilled at 3-3/16" on center spacing. 10 holes for 36" rail, 12 holes for 42" rail. Engineered to meet code with posts at 60" on center spacing. Includes 4 ea. bolt cap covers. **Fasteners for mounting base plate to deck sold separately.**

36" Rail Height (2-3/8" x 35")

Item #: FXCIP200BLK35KIT - Black
Item #: FXCIP200BRZ35KIT - Bronze
Item #: FXCIP200WHT35KIT - White
Item #: FXCIP200SIL35KIT - Silver

42" Rail Height (2-3/8" x 41")

Item #: FXCIP200BLK41KIT - Black
Item #: FXCIP200BRZ41KIT - Bronze
Item #: FXCIP200WHT41KIT - White
Item #: FXCIP200SIL41KIT - Silver

Base Plate Post Skirts are Available
See page 149



ACTUAL FREIGHT CHARGES WILL BE APPLIED TO ALL RAILFXTM ORDERS

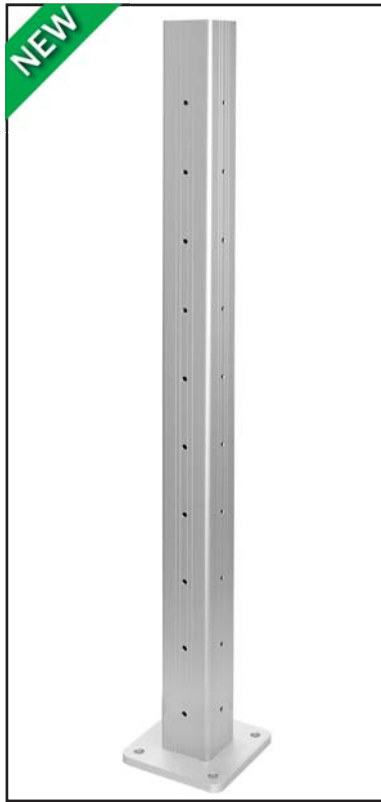

Available in:

- Black
- Bronze
- White
- Silver

Surface Mount Single Corner Post - Pre-Drilled

Sold in any quantity.

2-3/8" Square surface mount post with 5" base plate. Base plate holes for fasteners are 3/8". Pre-drilled post is drilled at 3-3/16" on center spacing. 10 holes for 36" rail, 12 holes for 42" rail. Engineered to meet code with posts at 60" on center spacing. Includes 4 ea. bolt cap covers. **Fasteners for mounting base plate to deck sold separately.**

36" Rail Height (2-3/8" x 35")

- Item #: FXCCP200BLK35KIT - Black
- Item #: FXCCP200BRZ35KIT - Bronze
- Item #: FXCCP200WHT35KIT - White
- Item #: FXCCP200SIL35KIT - Silver

42" Rail Height (2-3/8" x 41")

- Item #: FXCCP200BLK41KIT - Black
- Item #: FXCCP200BRZ41KIT - Bronze
- Item #: FXCCP200WHT41KIT - White
- Item #: FXCCP200SIL41KIT - Silver

Base Plate Post Skirts are Available
See page 149

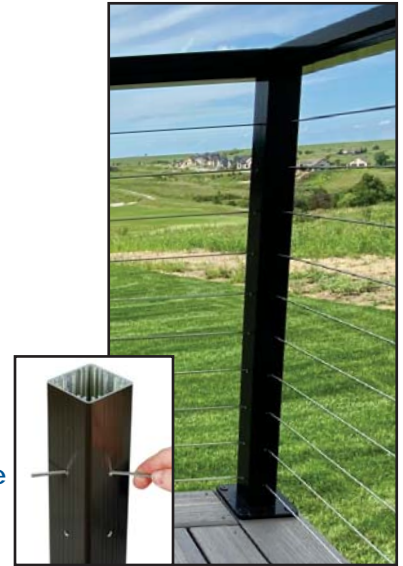

Available in:

- Black
- Bronze
- White
- Silver

Pre-Drilled Post for Stair Applications

Sold in any quantity.

2-3/8" Square Pre-drilled stair post for cable system. Due to many variables in stairs, these posts do not come with base plate attached. This allows post to be placed, adjusted and mounted where desired. Stair post holes are slotted and drilled at 3-3/16" on center and offset to allow cables to pass through at the angle of the stair. 46" length allows post to be cut to appropriate height.

36" Rail Height (2-3/8" x 46")

- Item #: FXFMSCIP200BLK46 - Black
- Item #: FXFMSCIP200BRZ46 - Bronze
- Item #: FXFMSCIP200WHT46 - White
- Item #: FXFMSCIP200SIL46 - Silver

42" Rail Height (2-3/8" x 52")

- Item #: FXFMSCIP200BLK52 - Black
- Item #: FXFMSCIP200BRZ52 - Bronze
- Item #: FXFMSCIP200WHT52 - White
- Item #: FXFMSCIP200SIL52 - Silver

Requires Base Plate for Surface Mounting
Reference next page



ACTUAL FREIGHT CHARGES WILL BE APPLIED TO ALL RAILFX™ ORDERS

RailFX™ Mounting Brackets and Hardware



Available in:

Black

Bronze

White

Silver

5" x 5" Standard Base Plate

Sold in any quantity.

5" x 5" x 3/8" Aluminum base plate used to convert fascia posts to surface mount post for stair applications. Base plate holes for fasteners are 3/8". Includes 4 ea. bolt cap covers and 4 ea. 5/16" x 2" stainless steel screws. Use T40 torx bit for installation.

Item #: FXBPBLKKIT - Black
Item #: FXBPBRZKIT - Bronze
Item #: FXBPWHTKIT - White
Item #: FXBPSILKIT - Silver

Item # FXINSTKIT - Post Base Install Kit



Available in:

Black

Bronze

White

Silver

5" x 5" Angle / Knee Wall Base Plate

Sold in any quantity.

5" x 5" x 3/8" Slotted, adjustable aluminum base plate used for 2x6 knee wall applications (32° - 38°). Base plate holes for fasteners are 3/8". Includes 4 ea. bolt cap covers and 4 ea. 5/16" x 2" stainless steel screws. Use T40 torx bit for installation. Requires grinding of bolt head for flush bottom.

Item #: FXBPKWBLKKIT - Black
Item #: FXBPKWBRZKIT - Bronze
Item #: FXBPKWWHTKIT - White
Item #: FXBPKWSILKIT - Silver

Item # FXINSTKIT - Post Base Install Kit

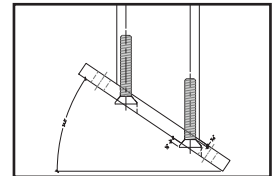

Available in:

Black

Bronze

White

Silver

3" x 5" Narrow Base Plate

Sold in any quantity.

3" x 5" x 3/8" Aluminum base plate used to convert fascia posts to surface mount post. Base plate holes for fasteners are 3/8". Includes 4 ea. bolt cap covers and 4 ea. 5/16" x 2" stainless steel screws. Use T40 torx bit for installation.

Item #: FXBP3X5BLKKIT - Black
Item #: FXBP3X5BRZKIT - Bronze
Item #: FXBP3X5WHTKIT - White
Item #: FXBP3X5SILKIT - Silver

Item # FXINSTKIT - Post Base Install Kit



Available in:

Black

Bronze

White

Silver

3" x 7" Narrow Angle / Knee Wall Base Plate

Sold in any quantity.

3" x 7" x 3/8" Slotted, adjustable aluminum base plate used for 2x4 knee wall applications (32° - 38°). Base plate holes for fasteners are 3/8". Includes 4 ea. bolt cap covers and 4 ea. 5/16" x 2" stainless steel screws. Use T40 torx bit for installation. Requires grinding of bolt head for flush bottom.

Item #: FXBP3X7SLOTBLKKIT - Black
Item #: FXBP3X7SLOTBRZKIT - Bronze
Item #: FXBP3X7SLOTWHTKIT - White
Item #: FXBP3X7SLOTSILKIT - Silver

Item # FXINSTKIT - Post Base Install Kit

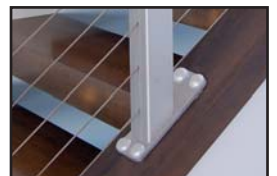

ACTUAL FREIGHT CHARGES WILL BE APPLIED TO ALL RAILFXTM ORDERS

RailFXTM Fascia Mount Posts and Brackets

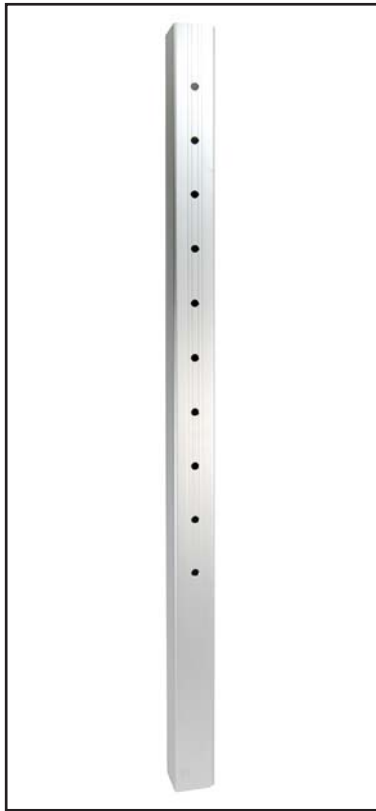

Available in:

Black

Bronze

White

Silver

Fascia Mount End Post - Pre-Drilled

Sold in any quantity.

2-3/8" Square fascia mount post for cable system. Pre-drilled post is drilled at 3-3/16" on center spacing. 10 holes for 36" rail, 12 holes for 42" rail. Engineered to meet code with posts at 60" on center spacing. Fascia brackets sold separately.

36" Rail Height (2-3/8" x 46")

Item #: FXFMCEP200BLK46 - Black
Item #: FXFMCEP200BRZ46 - Bronze
Item #: FXFMCEP200WHT46 - White
Item #: FXFMCEP200SIL46 - Silver

42" Rail Height (2-3/8" x 52")

Item #: FXFMCEP200BLK52 - Black
Item #: FXFMCEP200BRZ52 - Bronze
Item #: FXFMCEP200WHT52 - White
Item #: FXFMCEP200SIL52 - Silver



Available in:

Black

Bronze

White

Silver

Fascia Mount Intermediate Post - Pre-Drilled

Sold in any quantity.

2-3/8" Square fascia mount post for cable system. Pre-drilled post is drilled at 3-3/16" on center spacing. 10 holes for 36" rail, 12 holes for 42" rail. Engineered to meet code with posts at 60" on center spacing. Fascia brackets sold separately.

36" Rail Height (2-3/8" x 46")

Item #: FXFMCIP200BLK46 - Black
Item #: FXFMCIP200BRZ46 - Bronze
Item #: FXFMCIP200WHT46 - White
Item #: FXFMCIP200SIL46 - Silver

42" Rail Height (2-3/8" x 52")

Item #: FXFMCIP200BLK52 - Black
Item #: FXFMCIP200BRZ52 - Bronze
Item #: FXFMCIP200WHT52 - White
Item #: FXFMCIP200SIL52 - Silver



ACTUAL FREIGHT CHARGES WILL BE APPLIED TO ALL RAILFX™ ORDERS



Available in:

- Black
- Bronze
- White
- Silver

Pre-Drilled - Fascia Mount Stair Post

Sold in any quantity.

2-3/8" Square fascia mount post for use as an intermediate stair post. Stair post holes are slotted and drilled at 3-3/16" on center and offset to allow cables to pass through at the angle of the stair.

Fascia brackets sold separately.

36" Rail Height (2-3/8" x 46")

- Item #: FXFMSCIP200BLK46 - Black
- Item #: FXFMSCIP200BRZ46 - Bronze
- Item #: FXFMSCIP200WHT46 - White
- Item #: FXFMSCIP200SIL46 - Silver

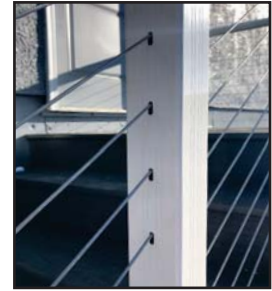

42" Rail Height (2-3/8" x 52")

- Item #: FXFMSCIP200BLK52 - Black
- Item #: FXFMSCIP200BRZ52 - Bronze
- Item #: FXFMSCIP200WHT52 - White
- Item #: FXFMSCIP200SIL52 - Silver

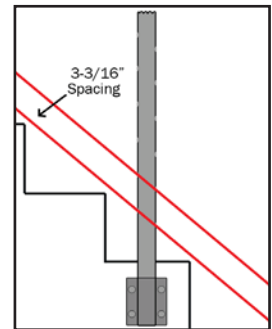

Available in:

- Black
- Bronze
- White
- Silver

6" Fascia Bracket

Sold in any quantity.

Mounts 2-3/8" post to deck fascia. Bracket offsets post 1-1/4" out from fascia. Includes 4 fascia screws, 4 bolt cap covers and 1 bottom plate w/ screws. Mounting hardware is not included.

- Item # FXFMIPB200BLK6 - Black
- Item # FXFMIPB200BRZ6 - Bronze
- Item # FXFMIPB200WHT6 - White
- Item # FXFMIPB200SIL6 - Silver



Available in:

- Black
- Bronze
- White
- Silver

Fascia Bracket - Outside Corner

Sold in any quantity.

Mounts 2-3/8" posts to deck fascia. This bracket is required to maintain 4" spacing on outside corners. Bracket offsets post 1-1/4" out from fascia. Includes 8 fascia screws, 4 bolt cap covers and 2 bottom plates w/ screws. Mounting hardware is not included.

- Item #: FXFMOCB200BLK6 - Black
- Item #: FXFMOCB200BRZ6 - Bronze
- Item #: FXFMOCB200WHT6 - White
- Item #: FXFMOCB200SIL6 - Silver



ACTUAL FREIGHT CHARGES WILL BE APPLIED TO ALL RAILFXTM ORDERS



Available in:

Black

Bronze

White

Silver



Flush Mount Fascia Post Kit

Sold in any quantity.

Components needed to flush mount 2-3/8" post directly to deck fascia. Includes 2 ea. 7" lag screws, 2 ea. bolt cap covers w/ cup washer, 2 ea. 10" flat infill, and 1 ea. bottom cover plate w/ screws.

Item # FXFMFINSTKITBLK - Black
Item # FXFMFINSTKITBRZ - Bronze
Item # FXFMFINSTKITWHT - White
Item # FXFMFINSTKITSIL - Silver



Available in:

Black

Bronze

White

Silver



Fascia Post Bottom Plate - Replacement

Sold in any quantity.

Bottom plate is used to close off the bottom of RailFXTM fascia mount posts. Includes 2 ea. screws for attachment. Included in the flush mount fascia post kit.

Item # FXFMPBPBLK - Black
Item # FXFMPBPBRZ - Bronze
Item # FXFMPBPWHT - White
Item # FXFMPBPSIL - Silver



Available in:

Black

Bronze

White

Silver



Post Skirt

Sold in any quantity.

2 Piece post skirt to cover standard 5" x 5" post baseplate and hardware. Measures 5-1/4" x 1-5/8" with 2-3/8" opening.

Item # FXSKIRTBLK - Black
Item # FXSKIRTBRZ - Bronze
Item # FXSKIRTWHT - White
Item # FXSKIRTSIL - Silver



ACTUAL FREIGHT CHARGES WILL BE APPLIED TO ALL RAILFX™ ORDERS

RailFX™ Under Rail Lighting System

Series 200 Top Rail

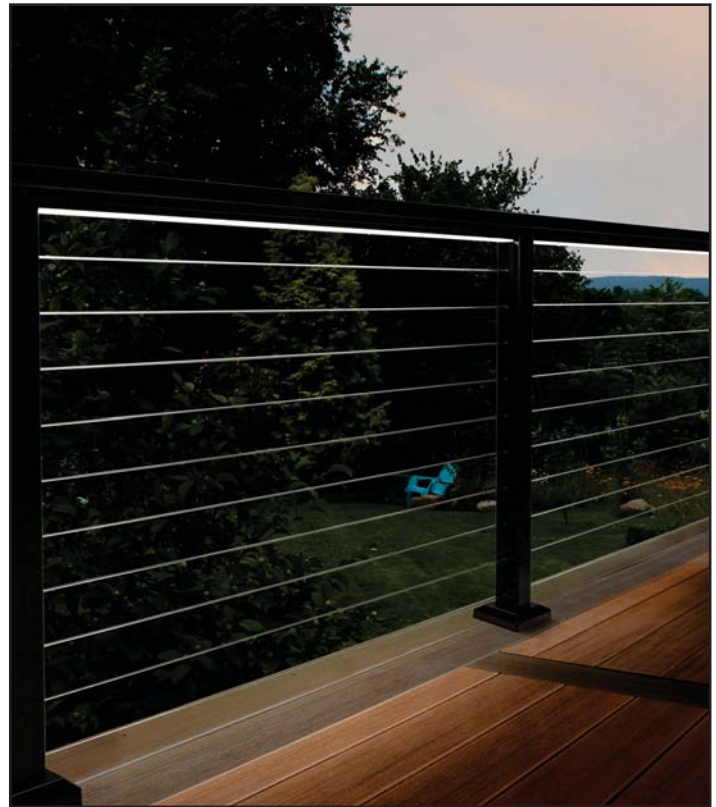

Available in:

- Black
- Bronze
- White
- Silver

Series 200 Top Rail

Sold in any quantity.

3-1/2" x 1-7/8" x 94" Series 200 aluminum top rail. Join multiple rails together with splices to achieve any length required. Field trimmable with carbide blade. Infill for lighting sold separately, see below.

End plate sold separately.

8' Top Rail (3-1/2" x 1-7/8" x 94")

- Item #: FXTR200BLKKIT8 - Black
- Item #: FXTR200BRZKIT8 - Bronze
- Item #: FXTR200WHTKIT8 - White
- Item #: FXTR200SILKIT8 - Silver



Available in:

- Black
- Bronze
- White
- Silver

60" Top Rail Lighting Infill

Sold in any quantity.

Infill installs into the bottom of series 200 top rail. Designed with a channel that allows for lighting to be added. Lights and diffuser lens sold separately (See next page). Field trimmable with carbide blade.

- Item #: FXFIG200BLK5 - Black
- Item #: FXFIG200BRZ5 - Bronze
- Item #: FXFIG200WHT5 - White
- Item #: FXFIG200SIL5 - Silver



ACTUAL FREIGHT CHARGES WILL BE APPLIED TO ALL RAILFXTM ORDERS



DekPro™ EFFEX LED Light Strip

Sold in any quantity.

Light strip uses 3M adhesive backing to attach to inside of infill channel. Trimmable to length in 2" increments. Features 2 quick connect leads for easy wiring.

Item #: DPSL55 - 55" Strip Light (4.5 Watts)



DekPro Quick Connect System

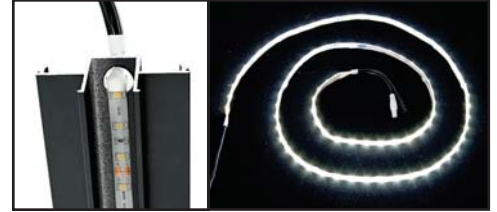

60" Diffuser Lens

Sold in any quantity.

Diffuser lens snaps onto rail to produce a soft, even light that illuminates cables and deck surface.

Item #: FXFILENS60 - 60" Diffuser Lens



Made in USA



DekPro™ EFFEX Transformer Kit

Sold in any quantity.

Kit includes 1 Outdoor DC output transformer w/ Quick Connect lead, 1 timer / photo cell, 1 dimmer with remote control, 1 Y-splitter and 1 - 9' Quick Connect wire. Dimmer draws **2.5 watts**. Determine correct transformer size by adding up wattage of all fixtures. Total wattage should not exceed 80% of the capacity of the transformer. (100 watt transformer has two outputs).

Item # DP36WTRANSKIT - 36 watt transformer kit
Item # DP60WTRANSKIT - 60 watt transformer kit
Item # DP100WTRANSKIT - 100 watt transformer kit



DekPro Quick Connect System



DekPro™ EFFEX 9' Quick Connect Cable

Sold in any quantity.

9' Cables come with water tight Quick Connect fittings on each end. Cables connect into DekPro™ EFFEX lighting components. Used when running wiring through top rail of aluminum railing system (i.e. DekPro™ Prestige)

Item # DP9CABLEMF



DekPro Quick Connect System

ACTUAL FREIGHT CHARGES WILL BE APPLIED TO ALL RAILFX™ ORDERS

RailFX™ Accessories



Available in:

Black

Bronze

White

Silver



Bolt Cap Cover Kit

Sold in packs of 4.

Covers lag screw heads for a clean, finished look. Includes nylon cap and stainless steel cup washer.

Item #: FXBOLTCAPBLKKIT - Black
Item #: FXBOLTCAPBRZKIT - Bronze
Item #: FXBOLTCAPWHTKIT - White
Item #: FXBOLTCAPSILKIT - Silver



5"

Available in:

Stainless Steel



Stainless Steel Lag Screw for Post Base

Sold in any quantity.

3/8" Lag used to attach post base to deck or for mounting fascia posts. Use 9/16" socket.

Item #: FXSCREWLAG5 - 5" Lag Screw (Surface mount)
Item #: FXSCREWLAG7 - 7" Lag Screw (Fascia mount w/o brackets)



7"



Available in:

Stainless Steel



Fascia Bracket Screw - Replacement

Sold in any quantity.

#14 x 1" Hex head stainless steel fascia bracket screw. Use for securing post to fascia bracket. Requires 4 per bracket. Brackets come with screws - these are for replacement only. Use 3/8" socket.

Item #: FXSSFS - Fascia Screw



Available in:

Black

Bronze

White

Stainless Steel

Walnut Woodgrain



Color Matched Screws

Sold in 100 Pack.

#10 - 3/4" phillips head screw attaches top rail to posts, and also used for splices.

Item #: FXSCREWBKWK805 - Black
Item #: FXSCREWBWZWK805 - Bronze
Item #: FXSCREWWHTW805 - White
Item #: FXSCREWSSW805 - Stainless Steel
Item #: FXSCREWWALW805-1 - Walnut Woodgrain (sold as eaches)

ACTUAL FREIGHT CHARGES WILL BE APPLIED TO ALL RAILFXTM ORDERS



- Available in:
- Absolute Black
 - Cocoa Bronze
 - Dream White
 - Silver

DekPro™ EFFEY Vertical Post Light for RailFX Post

Sold in any quantity.

EFFEY LED Vertical Post Light is great for illuminating decks or walkways. Includes 2 ea. - 3' Quick Connect leads. Draws **2.8 watts** per fixture. Measures 3-1/2" H x 1-3/4" W x 7/8" T. Light color - 3500.

- Item # DPPLABT - Absolute Black (Textured)
- Item # DPPLCBT - Cocoa Bronze (Textured)
- Item # DPPLDWT - Dream White (Textured)
- Item # DPPLSIL - Silver



See pages 250-251 for power and wiring options



- Available in:
- Black
 - Bronze
 - White
 - Silver

2-3/8" Post Cap

Sold in any quantity.

Use to finish 2-3/8" post. Use screws or epoxy to secure to post. Typically used if Series 250 top rails end into side of post.

- Item #: FXPCBLK - Black
- Item #: FXPCBRZ - Bronze
- Item #: FXPCWHT - White
- Item #: FXPCSIL - Silver



- Available in:
- Black
 - Bronze
 - White
 - Silver

Touch-Up Paint

Sold in any quantity.

Touch up paint available to cover up scratches and cuts from installation.

Spray Can

- Item #: FXPAINTBLK - Black
- Item #: FXPAINTBRZ - Bronze
- Item #: FXPAINTWHT - White
- Item #: FXPAINTSIL - Silver



Internal Post Brace (IPB)

Sold in any quantity.

Internal post brace is used to strengthen RailFXTM end posts where cable tensioning is being applied. Can also be used as a splice for unique angles in the Series 200 top rail.

- Item # FXEPIF34 - 34" length
- Item # FXEPIF40 - 40" length



ACTUAL FREIGHT CHARGES WILL BE APPLIED TO ALL RAILFX™ ORDERS

1-1/2" Round Aluminum Handrail - Textured

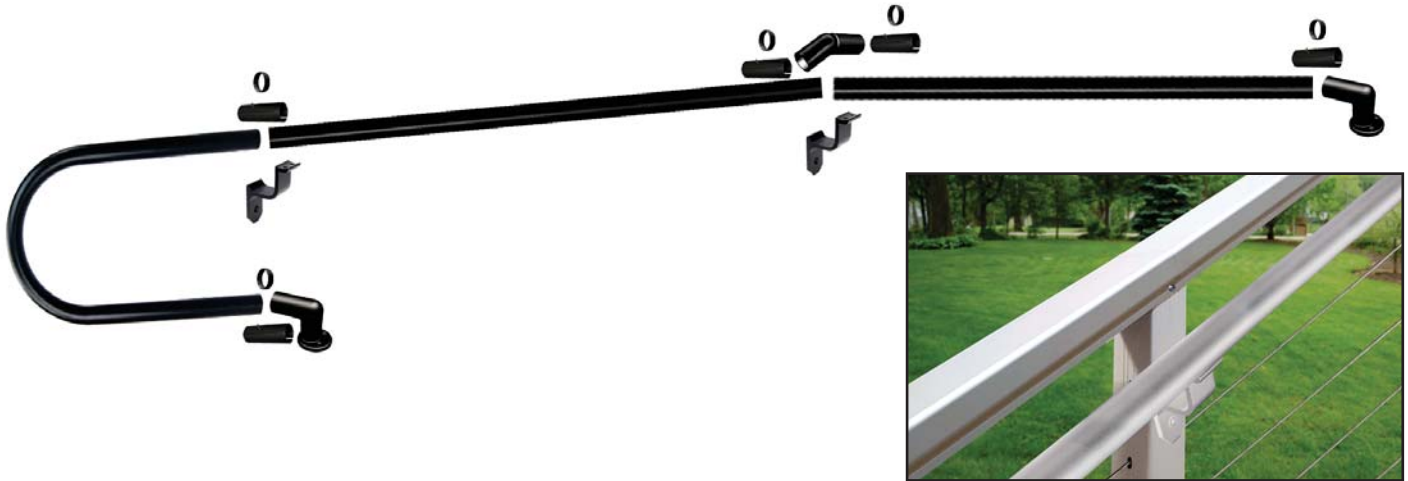

When Series 200 or 400 top rails are used on stairs that require secondary/graspable handrail



Available in:

- Black
- Bronze
- White
- Silver



96" & 92" - Straight Round Handrail

Sold in any quantity.

1-1/2" Round graspable handrail meets IRC requirements for secondary handrail system. Installs with screws or adhesive.

- Item # PR1596SHRABT - Textured Black
- Item # PR1596SHRCBT - Textured Bronze
- Item # PR1596SHRDWT - Textured White
- Item # PR1596SHRSILVER - Silver
- Item # PR1592SHRABT - Black
- Item # PR1592SHRCBT - Bronze
- Item # PR1592SHRDWT - White
- Item # PR1592SHRSILVER - Silver



Available in:

- Black
- Bronze
- White
- Silver



Universal Quick Return Bracket Kit

Sold in any quantity.

Returns 1-1/2" round handrail into post or wall. Works for any surface 2" or wider. Includes a handrail splice kit to connect to rail and color matched screws. Installs with screws or adhesive.

- Item # PRSHRQRABTKIT - Textured Black
- Item # PRSHRQRBCBTKIT - Textured Bronze
- Item # PRSHRQRDWTKIT - Textured White
- Item # PRSHRQRSILVERKIT - Silver



Available in:

- Black
- Bronze
- White
- Silver



Universal Mid-Rail Bracket

Sold in any quantity.

Attaches 1-1/2" round handrail to post or wall. Includes color matched screws. Mounts to any flat surface 2" or wider. Adjustable to any angle.

- Item # PRSHRMRBKTABT - Textured Black
- Item # PRSHRMRBKTCBT - Textured Bronze
- Item # PRSHRMRBKTDWT - Textured White
- Item # PRSHRMRBKTSILVER - Silver



ACTUAL FREIGHT CHARGES WILL BE APPLIED TO ALL RAILFX™ ORDERS



Available in:

Black

Bronze

White



Wall Mount Bracket

Sold in any quantity.

Attaches 1-1/2" round handrail straight into post or wall. Works for any surface 3-1/2" or wider. Includes a handrail splice kit to connect to rail and color matched screws. Installs with screws or adhesive.

Item # PRSHRWALLMTABT - Textured Black
Item # PRSHRWALLMTCBT - Textured Bronze
Item # PRSHRWALLMTDWT - Textured White



Available in:

Black

Bronze

White

Silver



Handrail Splice Kit

Sold in any quantity.

Splice kit joins straight 1-1/2" round handrail sections. Kit includes 1 splice and 1 splice ring. Splice ring is used to conceal the connection point. Installs with screws or adhesive.

Item # PRSHRSPLICEABTKIT - Textured Black
Item # PRSHRSPLICECBTKIT - Textured Bronze
Item # PRSHRSPLICEEDWTKIT - Textured White
Item # PRSHRSPLICESILVERKIT - Silver



Available in:

Black

Bronze

White

Silver



Multi-Angle Handrail Connector Kit

Sold in any quantity.

Connector kit joins 1-1/2" round handrail sections to allow for multi-angle connections to be made. Typically used for stair applications. Kit includes 1 multi-angle connector, 2 splices, and 2 splice rings. Installs with screws or adhesive.

Item # PRSHRUABTKIT - Textured Black
Item # PRSHRUACBTKIT - Textured Bronze
Item # PRSHRUADWTKIT - Textured White
Item # PRSHRUASILVERKIT - Silver



Available in:

Black

Bronze

White

Silver



90° Elbow - Inside / Outside Corner

Sold in any quantity.

90 degree rail used for inside and outside corner applications. **Requires a straight handrail splice at each end. (Sold Separately).** Each side has 12" of rail. Installs with screws or adhesive.

Item # PRSHRINSIDECABT - Textured Black
Item # PRSHRINSIDECGBT - Textured Bronze
Item # PRSHRINSIDECDWT - Textured White
Item # PRSHRINSIDECSSILVER - Silver



Available in:

Black

Bronze

White

Silver



Inside Corner Bracket

Sold in any quantity.

Attaches 1-1/2" round 90° elbow inside corner rail to corner of post. Includes color matched screws.

Item # PRSHRINSIDECBKTABT - Textured Black
Item # PRSHRINSIDECBKTCBT - Textured Bronze
Item # PRSHRINSIDECBKTDWT - Textured White
Item # PRSHRINSIDECBKTSILVER - Silver



ACTUAL FREIGHT CHARGES WILL BE APPLIED TO ALL RAILFX™ ORDERS



Available in:

- Black
- Bronze
- White
- Silver



P-Loop Return - ADA Compliant

Sold in any quantity.

180 degree handrail end loop is used to extend beyond post and return back to post. **Requires a handrail splice and 2 brackets to complete installation.** Installs with screws or adhesive

- Item # PRSHRPLOOPABT - Textured Black
- Item # PRSHRPLOOPCBT - Textured Bronze
- Item # PRSHRPLOOPDWT - Textured White
- Item # PRSHRPLOOPSILVER - Silver



Available in:

- Black
- Bronze
- White
- Silver



End Cap

Sold in any quantity.

Finishes end of handrail if not attaching back to post. Installs with screws or adhesive.

- Item # PRSHRENDCAPABT - Textured Black
- Item # PRSHRENDCAPCBT - Textured Bronze
- Item # PRSHRENDCAPDWT - Textured White
- Item # PRSHRENDCAPSILVER - Silver



Available in:

- Black
- Bronze
- White



Prestige Touch Up Paint

Sold in any quantity.

Sold in 11 oz. spray can or .3 oz paint pen to touch up rails.

Spray Can (11 oz):

- Item # PRPAINT12ABT - Black
- Item # PRPAINT12CBT - Bronze
- Item # PRPAINT12DWT - White

Paint Pen:

- Item # PRPAINTPENABT - Black
- Item # PRPAINTPENCBT - Bronze
- Item # PRPAINTPENDWT - White

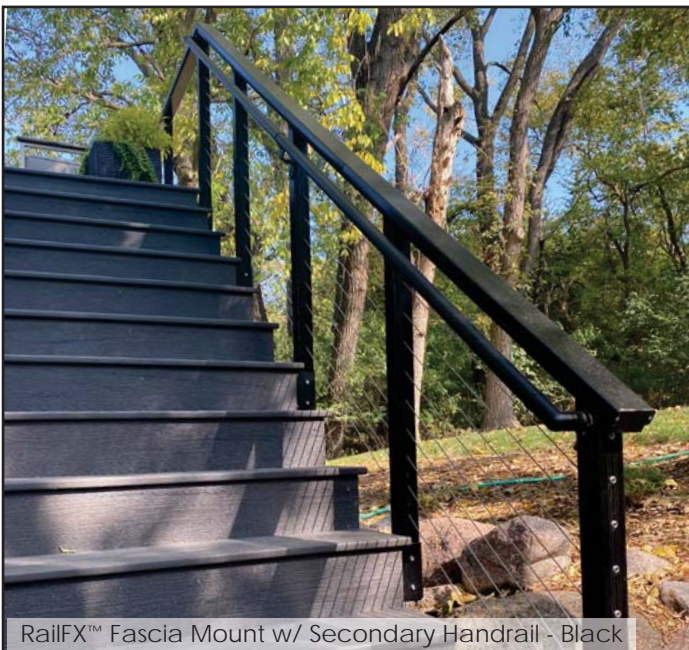

RailFX™ Fascia Mount w/ Secondary Handrail - Black

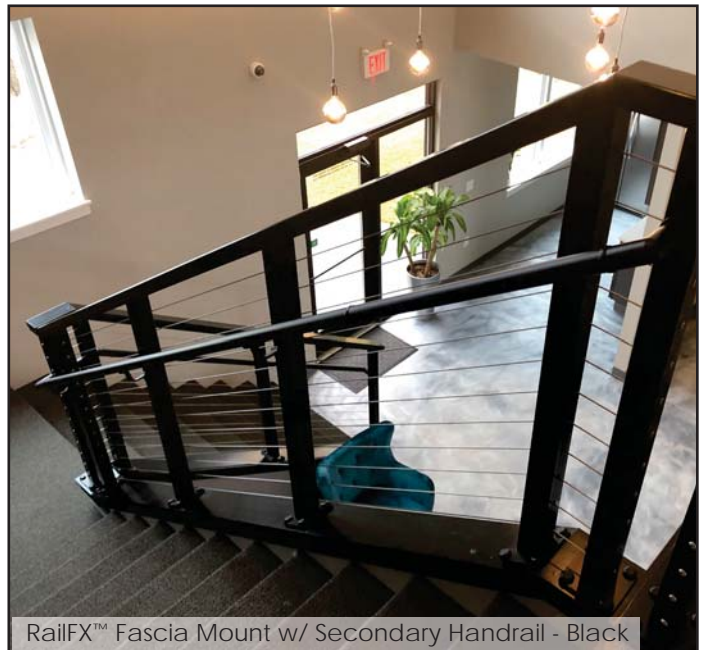

RailFX™ Fascia Mount w/ Secondary Handrail - Black

ACTUAL FREIGHT CHARGES WILL BE APPLIED TO ALL RAILFXTM ORDERS



RailFXTM Fascia Mount Rail w/ Cable - Black



RailFXTM Rail & Cable w/ Existing Columns - Black



RailFXTM Aluminum Rail & Cable - Silver

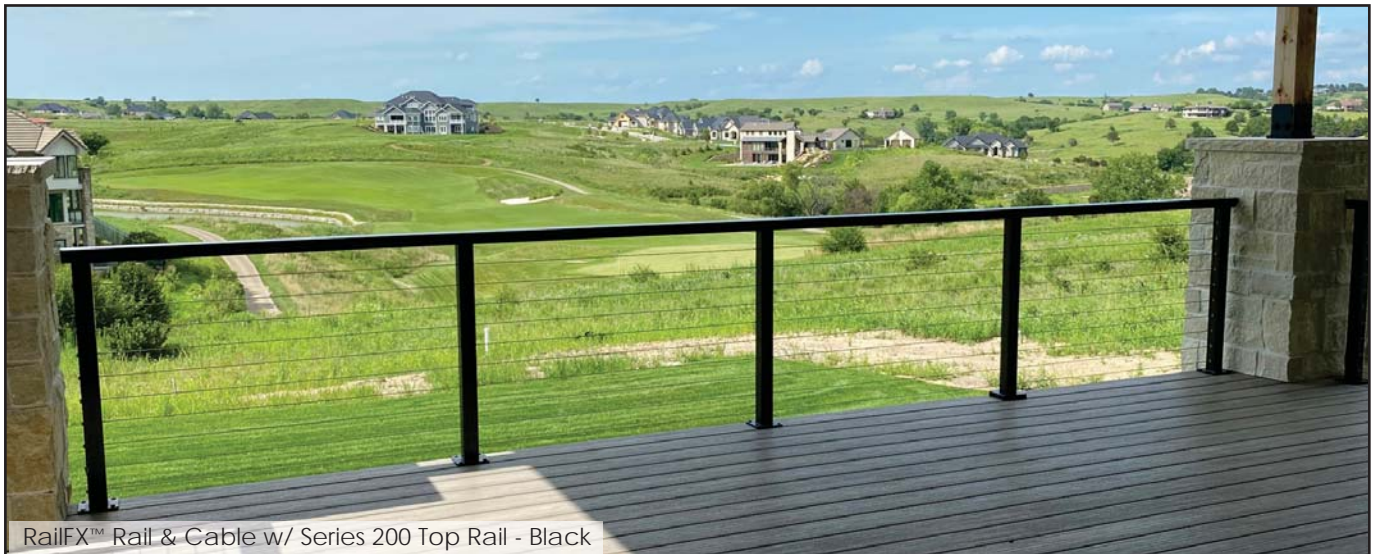

RailFXTM Rail & Cable w/ Series 200 Top Rail - Black

Fortress AL13 Home™ Vertical Cable Rail



Post to Post Railing System



Use the steps below for the following pages to complete your rail

STEP 1 Choose Panel
Vertical Cable Railing

STEP 3 Choose post (Includes Skirt)
3" Surface Mount Post

STEP 2 Choose Brackets (4 Pack)

STEP 4 Select Top Rail (ATR)
Flat or Round

Fortress™ AL¹³ Home™ Vertical Cable Railing System

Fortress AL13 Home™ cable railing system features fully assembled aluminum rails with vertical cable infill. Panels install easily with a simple bracket system. Aluminum construction, powder coat finish and stainless steel cables create a virtually maintenance free system designed for use in a variety of environments. Rail panels can be used as a complete system or they can be installed between posts of most materials.

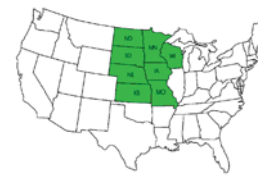

ACTUAL FREIGHT CHARGES APPLY TO ALL FORTRESSTM RAIL ORDERS



FortressTM Aluminum Vertical Cable Rail - Black Sand

Al¹³ HomeTM Vertical Cable Aluminum Panels



Top / bottom rail measure 1-1/4" x 1-1/4" and Infill is 1/8" cable for both level and stair panels.

6'rails include 4 ea. - 5/8" supports

8'rails include 6 ea. - 5/8" supports

Available in:

Black Sand

Matte White

6' - Vertical Cable Panel

Sold in any quantity

32.5" x 69.5" Vertical cable panel achieves a total railing height of 36".
40" x 69.5" Vertical cable panel achieves a total railing height of 42".

Requires the use of a Flat or Round Accent Top Rail (ATR) see next page.

36" Rail Height (32.5" x 69.5" Panel)

42" Rail Height (40" x 69.5" Panel)

Item # **59732698** - Black Sand (Txt)

Item # **59732691** - Matte White (Txt)

Item # **59740698** - Black Sand (Txt)

Item # **59740691** - Matte White (Txt)

8' - Vertical Cable Panel

Sold in any quantity

32.5" x 93.5" Vertical cable panel achieves a total railing height of 36".
40" x 93.5" Vertical cable panel achieves a total railing height of 42".

Requires the use of a Flat or Round Accent Top Rail (ATR) see next page.

36" Rail Height (32.5" x 93.5" Panel)

42" Rail Height (40" x 93.5" Panel)

Item # **59732938** - Black Sand (Txt)

Item # **59732931** - Matte White (Txt)

Item # **59740938** - Black Sand (Txt)

Item # **59740931** - Matte White (Txt)

Al¹³ HomeTM Adjustable Stair Vertical Cable Aluminum Panels



Available in:

Black Sand

Matte White

8' - Adjustable Stair Vertical Cable Panel

Sold in any quantity

Vertical Cable panel for stairs and ramps, achieves a total railing height of either 36" or 42". Panel adjustable from 5° - 45°.

Requires the use of a Flat or Round Accent Top Rail (ATR) see next page.

36" Rail Height (32.5" x 93.5" Panel)

42" Rail Height (40" x 93.5" Panel)

Item # **59832738** - Black Sand (Txt)

Item # **59832731** - Matte White (Txt)

Item # **59840738** - Black Sand (Txt)

Item # **59840731** - Matte White (Txt)

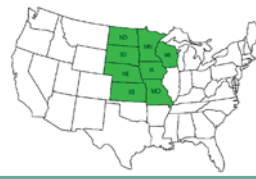

ACTUAL FREIGHT CHARGES APPLY TO ALL FORTRESSTM RAIL ORDERS

AI¹³ HomeTM Top Rail Covers



Available in:

- Black Sand
- Matte White

Flat Accent Top Rail (ATR)

Sold in any quantity.

Flat accent top rail snaps on top of rail panels to provide structural support and a finished design. Measures 100.875"L x 2-3/8"W x 1-5/8"H. Includes full length ATR spacer with hardware.

- Item # **59511018** - Black Sand (Textured)
- Item # **59511011** - Matte White (Textured)

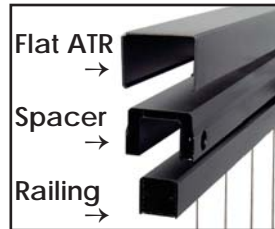

Available in:

- Black Sand
- Matte White

Round Accent Top Rail (ATR)

Sold in any quantity.

Round accent top rail snaps on top of rail panels to provide structural support and a finished design. Measures 100.875"L x 2-3/8"W x 2"H. Includes 6 ATR spacers with hardware.

- Item # **59501018** - Black Sand (Textured)
- Item # **59501011** - Matte White (Textured)

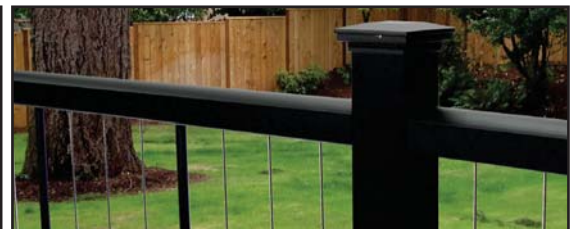
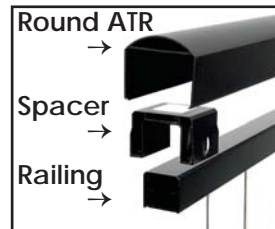

Available in:

- Black Sand
- Matte White

Cap Rail Clip for Drink Rail

Sold in packs of 4.

Cap rail clip used to attach a wood, vinyl or composite rail to the top of panel. Fits 1-1/4" square profile. Includes 4 cap rail clips, 2 bracket covers and hardware.

- Item # **59500078** - Black Sand (Textured)
- Item # **59500071** - Matte White (Textured)

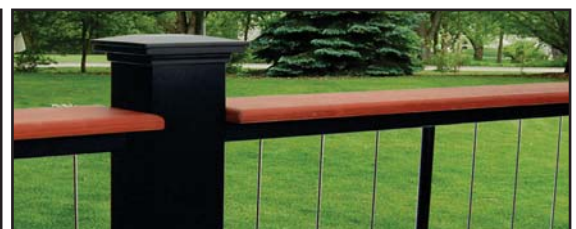



ACTUAL FREIGHT CHARGES APPLY TO ALL FORTRESSTM RAIL ORDERS

Al¹³ HomeTM Brackets



Available in:

- Black Sand
- Matte White

Level Bracket

Sold in packs of 4.

Top and bottom rails drop into brackets for level / straight applications. Includes snap cap cover for a finished look. Includes screws.

- Item # **59500218** - Black Sand (Textured)
- Item # **59500211** - Matte White (Textured)

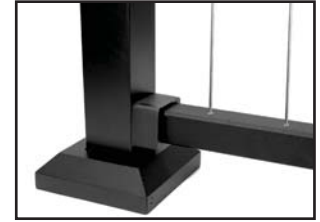

Available in:

- Black Sand
- Matte White

Stair Bracket

Sold in packs of 4.

Top and bottom rails drop into brackets for stair applications. Includes snap cap cover for a finished look. Adjustable for up to a 40 degree stair angle. Includes screws.

- Item # **59505078** - Black Sand (Textured)
- Item # **59505071** - Matte White (Textured)



Available in:

- Black Sand
- Matte White

Angle Bracket

Sold in packs of 4.

Top and bottom rails drop into brackets for level angle/miter applications. Includes snap cap cover for a finished look. Adjustable for up to a 45 degree horizontal angle. Includes screws.

- Item # **59500318** - Black Sand (Textured)
- Item # **59500311** - Matte White (Textured)



Black Sand

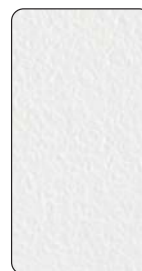

Matte White

Colors shown are an approximate representation only, please see actual product sample when selecting color

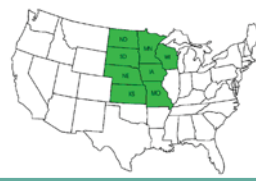

ACTUAL FREIGHT CHARGES APPLY TO ALL FORTRESS™ RAIL ORDERS



Available in:

- Black Sand
- Matte White

45 degree - Left Hand

Sold in any quantity

Left hand version - Top bracket cover for angle brackets at a 45 degree angle.

Flat 45 Left Hand Bracket

- Item # 59500518 - Black Sand (Textured)
- Item # 59500511 - Matte White (Textured)

Round 45 Left Hand Bracket

- Item # 59500298 - Black Sand (Textured)
- Item # 59500291 - Matte White (Textured)



Available in:

- Black Sand
- Matte White

45 degree - Right Hand

Sold in any quantity

Right hand version - Top bracket cover for angle brackets at a 45 degree angle.

Flat 45 Right Hand Bracket

- Item # 59500618 - Black Sand (Textured)
- Item # 59500611 - Matte White (Textured)

Round 45 Right Hand Bracket

- Item # 59500398 - Black Sand (Textured)
- Item # 59500391 - Matte White (Textured)

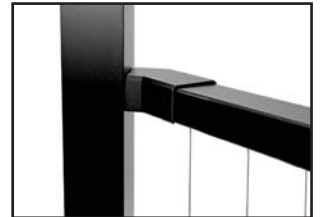

AI¹³ Home™ Posts



Available in:

- Black Sand
- Matte White

3" Post with 2 pc. Skirt

Sold in any quantity.

3" Aluminum posts with 5-1/2" flange and skirt. Flange holes are 1/2" for fasteners. **Includes skirt for base.**

3" x 39.5" Post

- Item # 59339038 - Black Sand (Textured)
- Item # 59339031 - Matte White (Textured)

3" x 45.5" Post

- Item # 59345038 - Black Sand (Textured)
- Item # 59345031 - Matte White (Textured)



FortressAccents™ 3" Post Cap

Sold in any quantity.

Accents flat die cast aluminum post cap for 3" post.

- Item # 52500038 - Black Sand (Textured)
- Item # 52500032 - Matte White (Textured)



3" Post Skirt - Replacement

Sold in any quantity.

Post base cover included. Also sold separately. Measures 5-3/4" x 1-1/2" with 3-1/8" opening.

- Item # 51500038 - Black Sand (Textured)
- Item # 59505751 - Matte White (Textured)

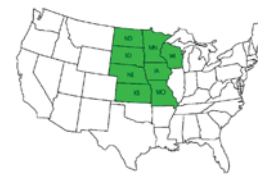

ACTUAL FREIGHT CHARGES APPLY TO ALL FORTRESSTM RAIL ORDERS



Available in:

- Black Sand
- Matte White

FortressAccentsTM Post Cap with Optional Light Kit

Sold in any quantity.

Accents flat die cast aluminum post cap for 3" post. Light kit draws 2 watts. Light color - 2600K. Includes wire nuts and 60" lead wire. Must purchase LED cap light kit along with cap.

3" Post Cap

- Item # 52500038 - Black Sand (Textured)
- Item # 52500032 - Matte White (Textured)

Light Kit

- Item # 52500000 - LED Light Kit



Item #: 52500000



Available in:

- Black Sand
- Matte White

FortressAccentsTM Post Cap with Optional Glow Ring

Sold in any quantity.

Accents flat die cast aluminum post cap for 3" Post. Glow ring draws 1.5 watts. Light color - 2600K. Includes wire nuts and 60" lead wire. Must purchase LED glow ring light along with cap.

3" Post Cap

- Item # 52500038 - Black Sand (Textured)
- Item # 52500032 - Matte White (Textured)

Glow Ring

- Item # 52503030 - 3" Glow Ring



Available in:

- Black Sand
- Matte White

Cable Panel Support Block - Replacement

Sold in any quantity

Support block used to add additional strength to the bottom rail of cable panels.

Level

- Item # 59532088 - Black Sand (Level)
- Item # 59532081 - Matte White (Level)

Stair

- Item # 59550078 - Black Sand (Textured)
- Item # 59550071 - Matte White (Textured)



Available in:

- Black Sand
- Matte White

Touch-Up Paint

Sold in any quantity.

Available in two convenient sizes.

Spray Can (6oz)

- Item # 660378 - Black Sand (Textured)
- Item # 660374 - Matte White (Textured)

Paint Pen

- Item # 660368 - Black Sand (Textured)
- Item # 660364 - Matte White (Textured)

Fortress™ Horizontal Cable Rail

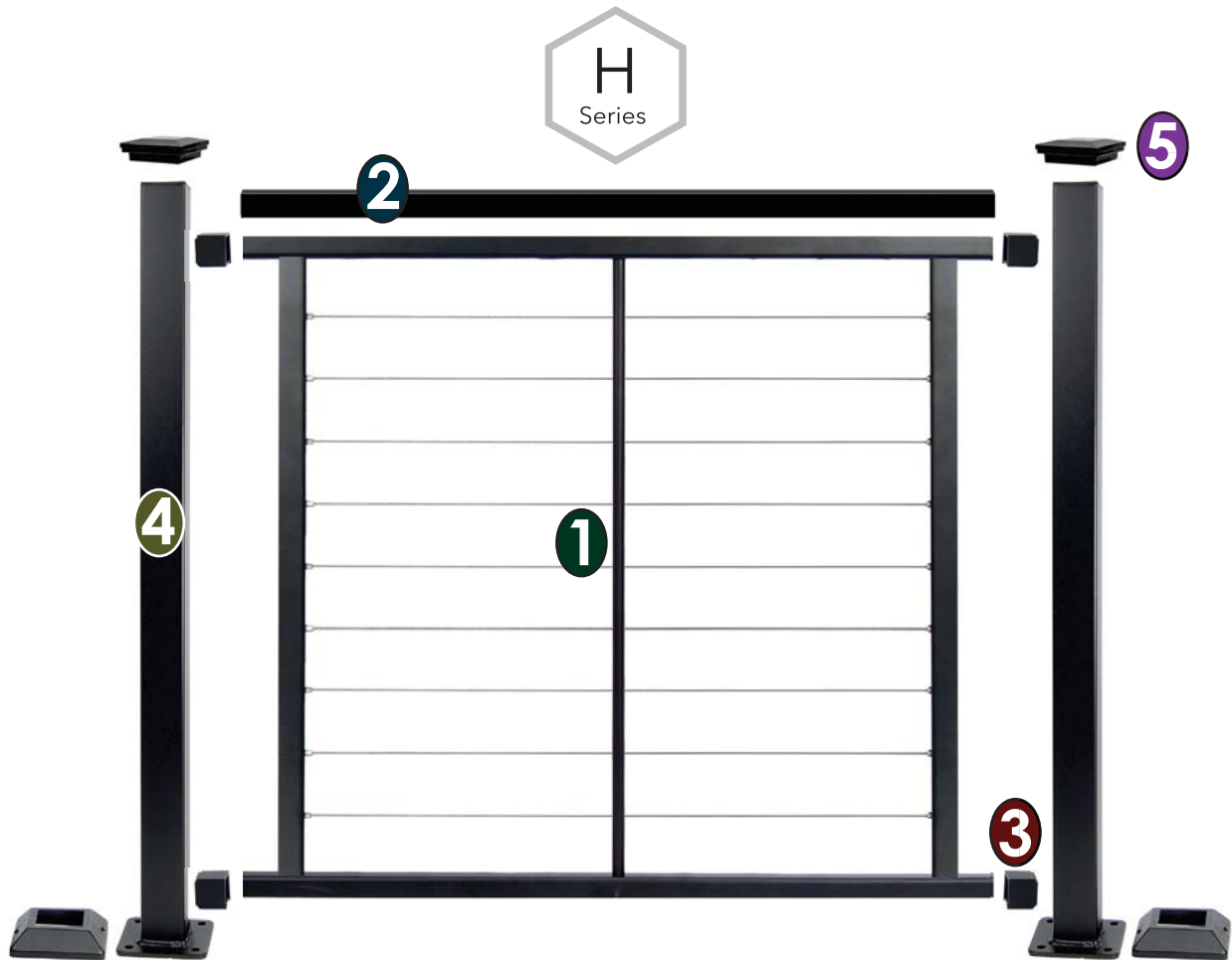

Use the steps below for the following pages to complete your rail system

STEP 1 Choose Cable Rail Panel

STEP 4 Choose Post (Includes Skirt)

STEP 2 Choose Top Rail Cover

STEP 5 Select a Post Cap

STEP 3 Choose Brackets (4 Pack)



6' Rails



8' Rails

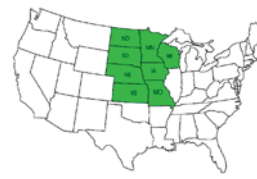

ACTUAL FREIGHT CHARGES APPLY TO ALL FORTRESS™ RAIL ORDERS



Fortress™ Horizontal Cable Rail - Black Sand

Fortress™ Horizontal Cable Railing Panel - Level



Top / bottom rail measure
1-1/4" x 1-1/4"

Available in:
Black Sand

Fe²⁶ Horizontal Cable Railing Panel

Sold in any quantity.

Fortress Fe²⁶ horizontal cable panel for 36" or 42" rail heights. Top/bottom rail measure 1-1/4" x 1-1/4" with 1/8" cable railing infill. **Must purchase flat top rail cover or add your own cap rail to complete rail.** Brackets sold separately, see next page.

6' - Fe²⁶ Horizontal Cable Railing Panel

36" Rail Height (34" x 69.5" Panel)

42" Rail Height (40" x 69.5" Panel)

Item # **57134618** - Black Sand (Txt)

Item # **57140618** - Black Sand (Txt)

8' - Fe²⁶ Horizontal Cable Railing Panel

36" Rail Height (34" x 93.5" Panel)

42" Rail Height (40" x 93.5" Panel)

Item # **57134818** - Black Sand (Txt)

Item # **57140818** - Black Sand (Txt)

Fortress™ Horizontal Cable Railing Panel - Adjustable Stair

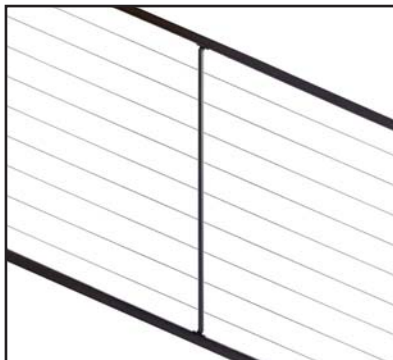

Available in:
Black Sand

8' - Fe²⁶ Horizontal Cable Adjustable Stair Panel

Sold in any quantity.

Fortress Fe²⁶ horizontal cable panel for 36" or 42" rail heights. Top/bottom rail measure 1-1/4" x 1-1/4" with 1/8" cable railing infill. Panel adjustable up to 38°. **Must purchase flat top rail cover or add your own cap rail to complete rail.** Brackets sold separately, see next page.

36" Rail Height (34" x 93.5" Panel)

42" Rail Height (40" x 93.5" Panel)

Item # **57234088** - Black Sand (Txt)

Item # **57240088** - Black Sand (Txt)



ACTUAL FREIGHT CHARGES APPLY TO ALL FORTRESSTM RAIL ORDERS



Available in:
Black Sand

Flat Top Rail Cover for Cable Rail

Sold in any quantity.

Flat accent rail is designed to fit over upper rail to provide a finished look and conceal cable rail hardware. Available in both 6' and 8' lengths.

Item # **57513608** - 6' Length (69.5" actual)
Item # **57513808** - 8' Length (93.5" actual)



Available in:
Black Sand

1-1/4" Cap Rail Clip for Cable Rail

Sold in bags of 4.

Clips allow for a clean smooth attachment of wood or composite rail to the top of FortressTM vertical cable panels. Clips are recommended every 2' along the rail. Includes screws.

Item # **57505058** - Black Sand (Textured)



FortressTM Rail Brackets

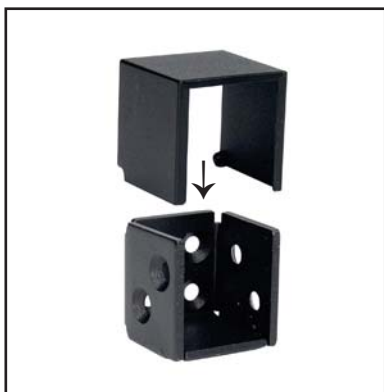

Available in:
Black Sand

Fe²⁶ 1-1/4" Universal Bracket - Level

Sold in Bags of 4.

Used for straight installation of FortressTM Fe²⁶ vertical cable panels to post. Includes screws for wood and metal applications.

1-1/4" Bracket for Accent Panels

Item # **53505008** - Black Sand (Textured)



Available in:
Black Sand

Fe²⁶ 1-1/4" Universal Angle Adapter Bracket for Stair and Side to Side

Sold in Bags of 4.

Angle Adapters used to convert 1-1/4" UB Bracket for stair installations. Turn 90 degrees for side to side application. **Purchase 1-1/4" UB Bracket separately.** Adjustable up to a 45 degree angle. Includes screws for wood and metal applications.

1-1/4" Bracket for Accent Panels

Item # **53505018** - Black Sand (Textured)



Combined View

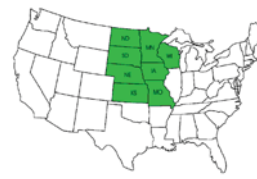

ACTUAL FREIGHT CHARGES APPLY TO ALL FORTRESS[™] RAIL ORDERS

Fortress[™] Posts, Caps & Skirts

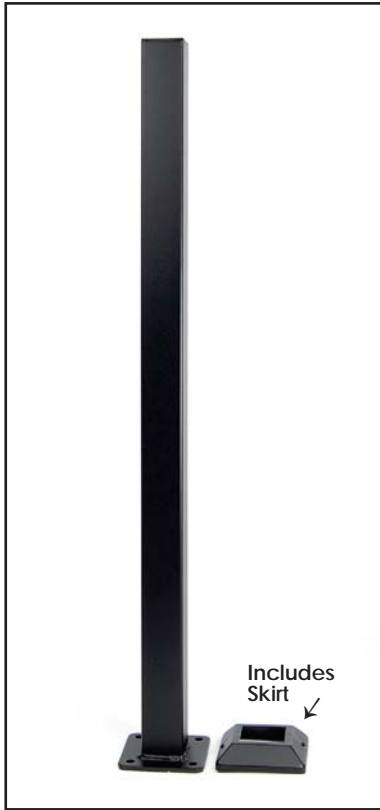

Available in:
Black Sand

Fe²⁶ - 2" Iron Post with 2 pc. Skirt

Sold in any quantity.

2" x 39-1/2" Iron post with 4" flange and skirt used to install panels at a 36" rail height. Flange holes are 1/2" for fasteners. **Includes skirt for base.**

Item # 53302418 - Black Sand (Textured)

2" x 45-1/2" Iron post with 4" flange and skirt used to install panels at a 42" rail height. Flange holes are 1/2" for fasteners. **Includes skirt for base.**

Item # 53302478 - Black Sand (Textured)



FortressAccents[™] 2" Post Cap

Sold in any quantity.

Accents flat die cast aluminum post cap for 2" post.

Item # 52500028 - Black Sand (Textured)



2" Post Skirt - Replacement

Sold in any quantity.

Fe²⁶ - 4" Post skirt included w/ post. **Also Sold separately.**

Item # 53504108 - Black Sand (Textured)



Available in:
Black Sand

Fe²⁶ - 3" Iron Post with 2 pc. Skirt

Sold in any quantity.

3" x 39-1/2" Iron post with 5-1/4" flange and skirt used to install panels at a 36" rail height. Flange holes are 1/2" for fasteners. **Includes skirt for base.**

Item # 53303418 - Black Sand (Textured)

3" x 45-1/2" Iron post with 5-1/4" flange and skirt used to install panels at a 42" rail height. Flange holes are 1/2" for fasteners. **Includes skirt for base.**

Item # 53303478 - Black Sand (Textured)



FortressAccents[™] 3" Post Cap

Sold in any quantity.

Accents flat die cast aluminum post cap for 3" post.

Item # 52500038 - Black Sand (Textured)



3" Post Skirt - Replacement

Sold in any quantity.

Fe²⁶ - 5-1/4" Post skirt included w/ post. **Also sold separately.**

Item # 53505108 - Black Sand (Textured)



ACTUAL FREIGHT CHARGES APPLY TO ALL FORTRESSTM RAIL ORDERS

Post Caps



Available in:
Black Sand

FortressAccentsTM Post Cap w/ Optional Light Kit

Sold in any quantity.

Accents flat die cast aluminum post cap for 2" and 3" posts. Light kit draws **2 watts**. Light color - 2600K. Includes wire nuts and 60" lead wire. **Must purchase LED cap light kit along with cap.**

2" Post Cap

Item # 52500028 - Black Sand (Txt)

Light Kit

Item # 52500000 - LED Light Kit

3" Post Cap

Item # 52500038 - Black Sand (Txt)

Light Kit

Item # 52500000 - LED Light Kit



Available in:
Black Sand

FortressAccentsTM Post Cap w/ Optional Glow Ring

Sold in any quantity.

Accents flat die cast aluminum post cap for 2" and 3" posts. Glow ring draws **1.5 watts**. Light color 2600K. Includes wire nuts and 60" lead wire. **Must purchase LED glow ring light along with cap.**

2" Post Cap

Item # 52500028 - Black Sand (Txt)

Glow Ring

Item # 52502020 - 2" Glow Ring

3" Post Cap

Item # 52500038 - Black Sand (Txt)

Glow Ring

Item # 52503030 - 3" Glow Ring



Available in:
Absolute Black

DekProTM EFEX 3" Post Caps

Sold in any quantity.

Optional DekPro aluminum post cap with textured finish. Available in pyramid or flat top styles with both non-lighted and lighted options. LED lights features Quick Connect wiring system for easy installation.

Item # DPPC3FABT - Flat Top
Item # DPPC3PABT - Pyramid

Item # DPPC3FDLABT - Flat Top Down Light
Item # DPPC3PDLABT - Pyramid Down Light

Item # DPPC3FBLABT - Flat Top Glow Ring
Item # DPPC3PBLABT - Pyramid Glow Ring



DekPro Quick Connect System



FortressTM Accessories



Available in:
Black Sand

Rail Support for Cable Rail

Sold in any quantity.

I-Support screws directly into the bottom of the horizontal cable support of the panel. Provides support to the bottom rail. Includes screws to fasten to deck.

Item # **57504248** - Horizontal Level Support
Item # **57505248** - Horizontal Stair Support



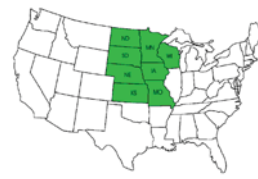

ACTUAL FREIGHT CHARGES APPLY TO ALL FORTRESS[™] RAIL ORDERS



Fortress[™] Horizontal Cable Rail - Black Sand

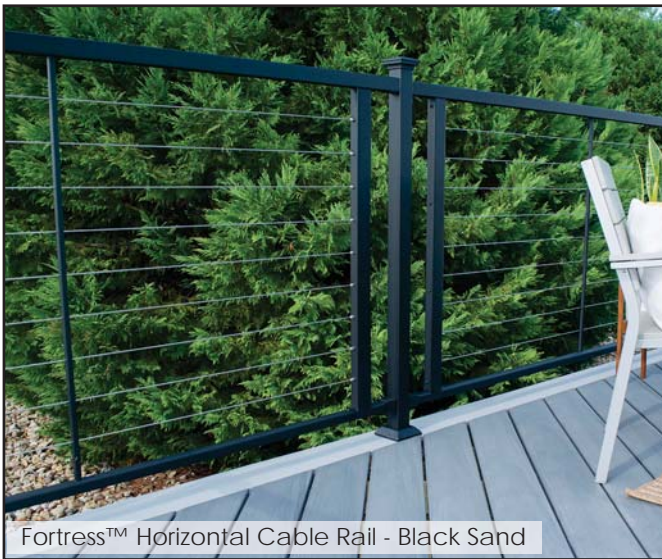

Fortress[™] Horizontal Cable Rail - Black Sand

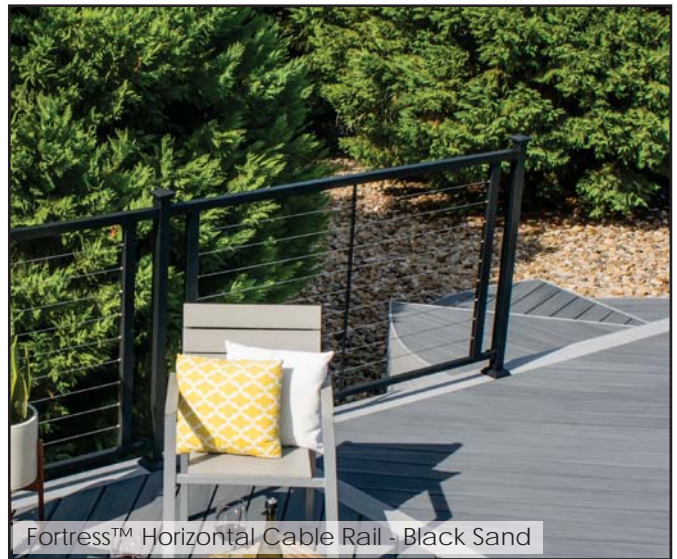

Fortress[™] Horizontal Cable Rail - Black Sand



Fortress[™] Horizontal Cable Rail - Black Sand

Sleeved Posts w/ Cable Overview

Framework For Aluminum Sleeved Wood Posts

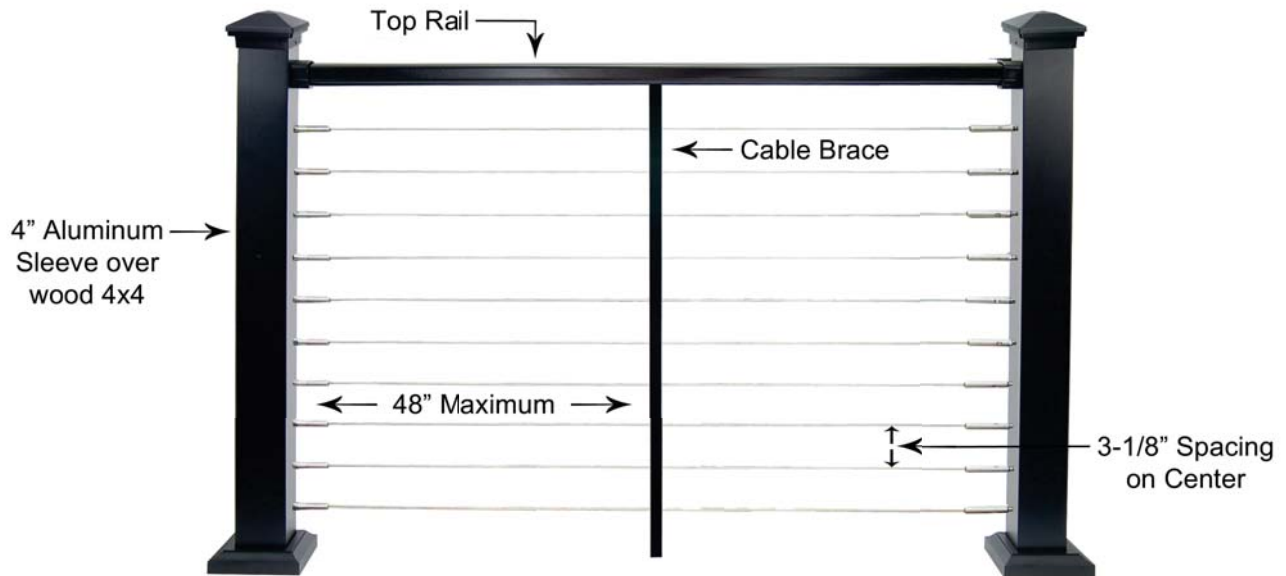

Guidelines for proper installation of the ADI™ cable railing system by Ultra-tec:

- Use 4" aluminum sleeve with a 4x4 wood post for structural support.
- Top rail is required to support posts. (Bottom rail is optional)
- Cables are to be spaced at 3-1/8" on center.
- Cable must be supported every 48" to keep the cable from deflecting over 4" to pass code.
- Cables are to be tensioned to 225 lbs of tension minimum.
- 36" Rail height typically uses 10 runs of cable, 42" rail height typically uses 12 runs of cable.
- Lag style cable fittings are required for cable used with sleeved posts.
- Cable kits must terminate at corner posts, or posts where the cable is at an angle.

For level runs using wood posts with aluminum sleeves.

(Outside diameter 4" or less)

RFXWLT - Tensioner Fitting

RFXWLN - Non-Tensioner Fitting

and Bulk Cable (100' or 500')

For stairs using wood posts with aluminum sleeves:

(Outside diameter 4" or less)

RFXWST - Stair Tensioner Fitting

RFXWSN - Stair Non-Tensioner Fitting

and Bulk Cable (100' or 500')

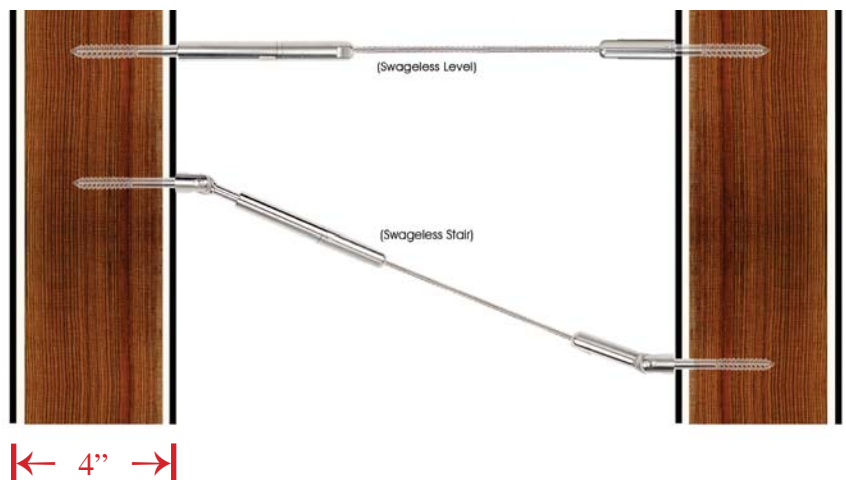

* If using sleeves over 4" in diameter - Use cable kits for composite sleeves. Reference pages 124 - 125

ACTUAL FREIGHT CHARGES APPLY TO ALL DEKPROTM PRESTIGE RAIL ORDERS

Cable Railing w/ Aluminum Sleeves

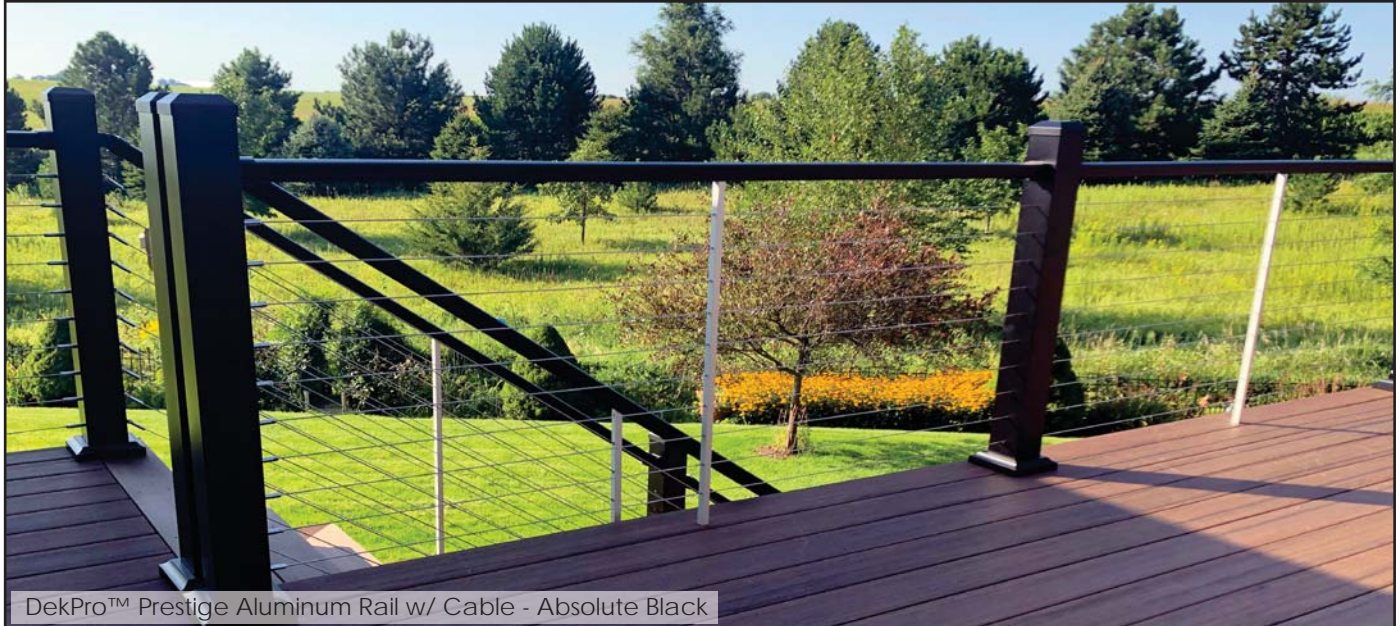

DekProTM Prestige Aluminum Rail w/ Cable - Absolute Black

Cable Railing for DekProTM Prestige 4" Sleeves



Level

FlexFXTM - Cable Fittings for Sleeves over Wood

Sold in any quantity.

Cable railing and fittings made in USA from high quality 316 grade stainless steel. Designed to work for aluminum sleeved wood posts. Pre-drill using 7/32" drill bit.

Level Cable Fittings

- Item #: RFXWLN1/8 - 1/8" Non-Tensioner
- Item #: RFXWLN1/8-10 - 1/8" Non-Tensioner (10 Pack)



- Item #: RFXWLT1/8 - 1/8" Tensioner
- Item #: RFXWLT1/8-10 - 1/8" Tensioner (10 Pack)



Stair

Stair Cable Fittings

- Item #: RFXWSN1/8 - 1/8" Non-Tensioner
- Item #: RFXWSN1/8-10 - 1/8" Non-Tensioner (10 Pack)



- Item #: RFXWST1/8 - 1/8" Tensioner
- Item #: RFXWST1/8-10 - 1/8" Tensioner (10 Pack)



Bulk Cable Spools

- Item #: RFXCABLE100 - 100' Spool of 1/8" Cable
- Item #: RFXCABLE500 - 500' Spool of 1/8" Cable



ACTUAL FREIGHT CHARGES APPLY TO ALL DEKPRO™ PRESTIGE RAIL ORDERS

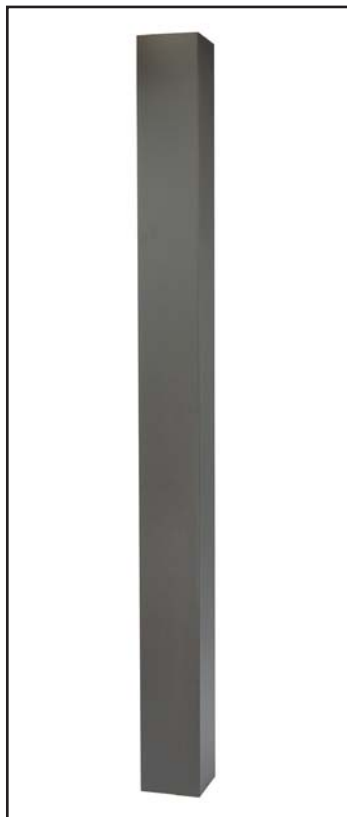

Available in:

- Absolute Black
- Cocoa Bronze
- Dream White
- Maple Cream

4" Aluminum Post Sleeve

Sold in any quantity.

4" textured sleeve designed to slide over a 3-5/8" wood post. Sleeves must be drilled to work with cable railing.

4" x 40"

- Item # PR4040PSLEEVEABT - Black
- Item # PR4040PSLEEVECBT - Bronze
- Item # PR4040PSLEEVEDWT - White
- Item # PR4040PSLEEVE MCT - Maple

4" x 54"

- Item # PR4054PSLEEVEABT - Black
- Item # PR4054PSLEEVECBT - Bronze
- Item # PR4054PSLEEVEDWT - White
- Item # PR4054PSLEEVE MCT - Maple

4" x 44"

- Item # PR4044PSLEEVEABT - Black
- Item # PR4044PSLEEVECBT - Bronze
- Item # PR4044PSLEEVEDWT - White
- Item # PR4044PSLEEVE MCT - Maple



4" Summit Pyramid Post Cap

Sold in any quantity.

- Item # DPPC4PABT - Absolute Black
- Item # DPPC4PCBT - Cocoa Bronze
- Item # DPPC4PDWT - Dream White
- Item # DPPC4PMCT - Maple Cream



4" Plateau Flat Top Post Cap

Sold in any quantity.

- Item # DPPC4FABT - Absolute Black
- Item # DPPC4FCBT - Cocoa Bronze
- Item # DPPC4FDWT - Dream White
- Item # DPPC4FMCT - Maple Cream



4" Post Skirt (2 Piece)

Sold in any quantity.

- Item # PR4SKIRTABT2PC - Absolute Black
- Item # PR4SKIRTCBT2PC - Cocoa Bronze
- Item # PR4SKIRTDWT2PC - Dream White
- Item # PR4SKIRTMCT2PC - Maple Cream



Available in:

- Absolute Black
- Cocoa Bronze
- Dream White
- Maple Cream

Aluminum Top Rail

Sold in any quantity.

Architectural style, textured powder coated aluminum top rail.

6' Top Rail (70")

- Item # PRPTR70ABT - Absolute Black
- Item # PRPTR70CBT - Cocoa Bronze
- Item # PRPTR70DWT - Dream White
- Item # PRPTR70MCT - Maple Cream

8' Top Rail (96-3/4")

- Item # PRPTR96ABT - Absolute Black
- Item # PRPTR96CBT - Cocoa Bronze
- Item # PRPTR96DWT - Dream White
- Item # PRPTR96MCT - Maple Cream



Top Rail Bracket

Each

For level top rail. Includes screws.

- Item # PRLBTABT - Absolute Black
- Item # PRLBTCBT - Cocoa Bronze
- Item # PRLBDWT - Dream White
- Item # PRLBTMCT - Maple Cream



Top Rail Stair Bracket

Each

For adjustable stair rail. Includes screws.

- Item # PRSBTABT - Absolute Black
- Item # PRSBTCBT - Cocoa Bronze
- Item # PRSBDWT - Dream White
- Item # PRSBTMCT - Maple Cream



Top Rail "Multi-Angle" Bracket

Each

For level rail side to side. Includes screws.

- Item # PRMATABT - Absolute Black
- Item # PRMATCBT - Cocoa Bronze
- Item # PRMATDWT - Dream White
- Item # PRMATMCT - Maple Cream

ACTUAL FREIGHT CHARGES APPLY TO ALL DEKPRO™ PRESTIGE RAIL ORDERS

Cable Brace

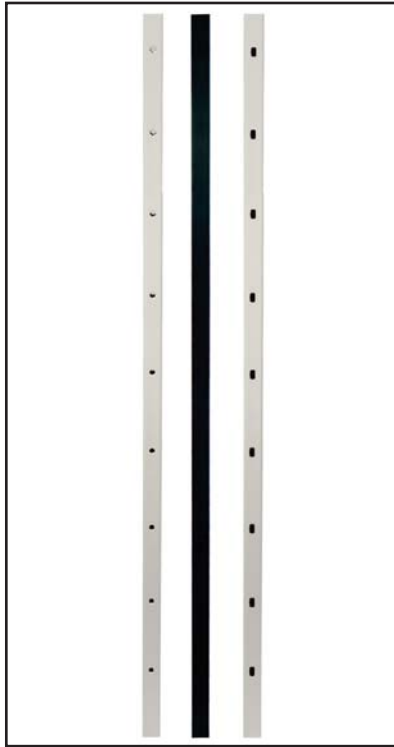

Available in:

- Black
- Anodized

Cable Brace for Level and Stair (1/8" Cable Only)

Sold in any quantity.

3/4" Aluminum cable brace is available pre-drilled with 12 holes at 3-1/8" spacing on center for level and stair runs. Available undrilled for unique installations. Trimmable to fit any rail height. Cable braces are used between newel posts that are greater than 48" apart to keep cables from deflecting over 4". Connectors and stainless steel screws included.

Pre-Drilled 42" Level

- Item # CB42BLAL13/P - Black
- Item # CB42ANAL13/P - Anodized

Pre-Drilled 50" Stair

- Item # CB50BL12/P - Black
- Item # CB50AN12/P - Anodized

Undrilled 42" Level or Stair

- Item # CB42BLAL/P - Black
- Item # CB42ANAL/P - Anodized

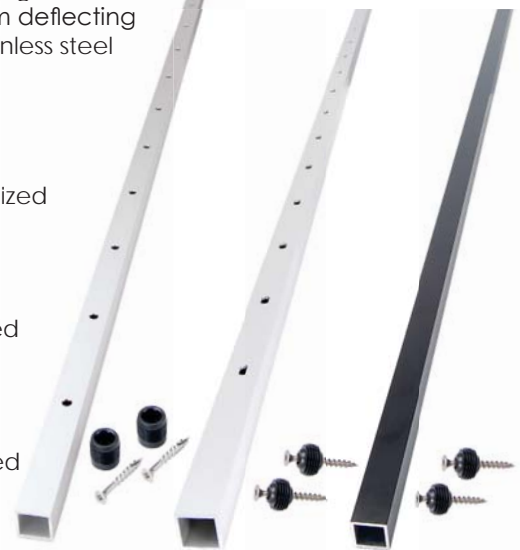

Pictures do not reflect full length of cable brace

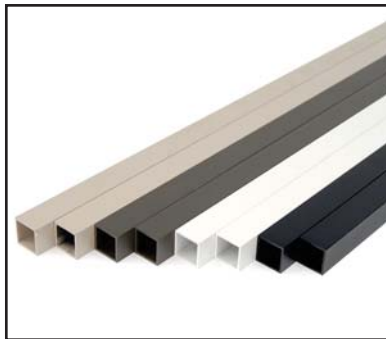

Available in:

- Absolute Black
- Cocoa Bronze
- Dream White
- Maple Cream

48" Textured Cable Brace - Undrilled

Sold in any quantity.

48" x 3/4" Square undrilled balusters to be used as intermediate cable supports to match DekPro Prestige railing colors. Connectors sold separately.

48" Baluster:

- Item # PR48SABT - Absolute Black
- Item # PR48SCBT - Cocoa Bronze
- Item # PR48SDWT - Dream White
- Item # PR48SMCT - Maple Cream

Connector:

- Item # DP374 - Level
- Item # DP377 - Stair (Black)
- Item # DP377BZ - Stair (Bronze)
- Item # DP377WH - Stair (White)

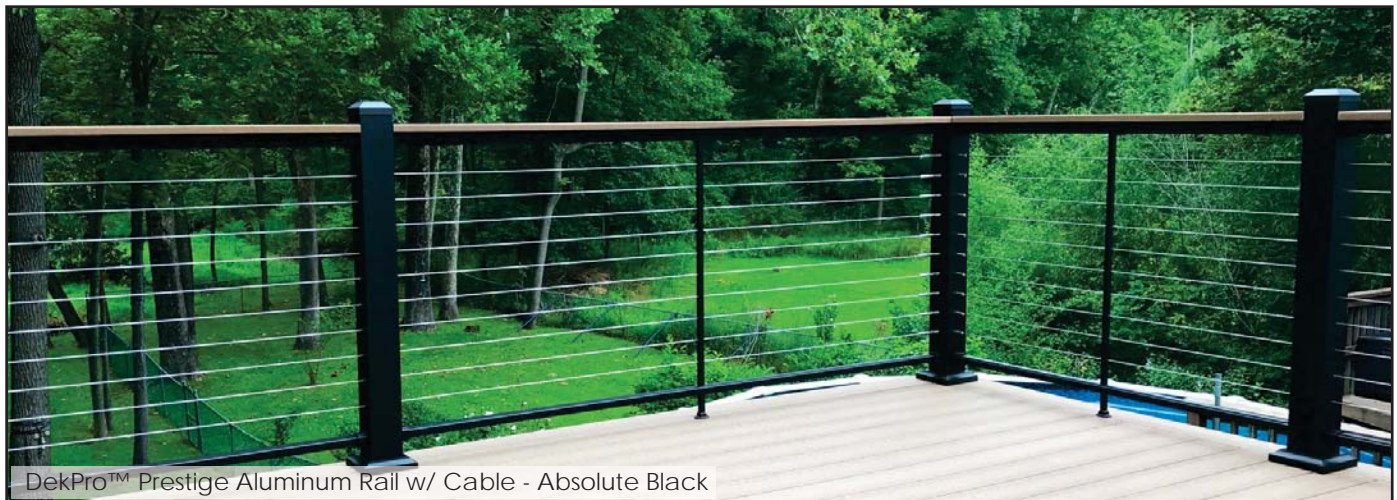

DekPro™ Prestige Aluminum Rail w/ Cable - Absolute Black

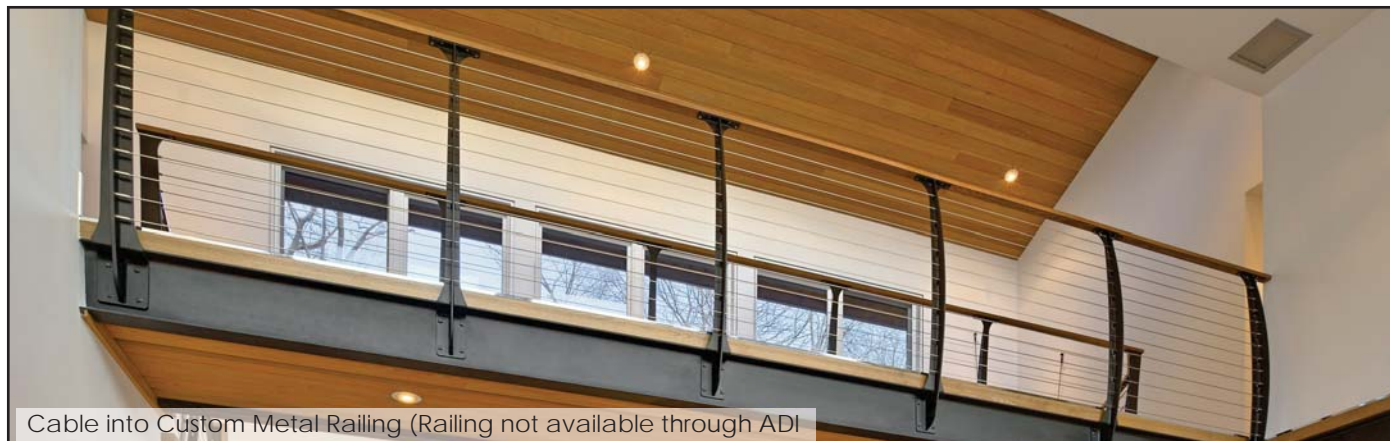

Cable into Custom Metal Railing (Railing not available through ADI)

Cable Railing for Metal - Level



FOR METAL

*1/4" Post Wall
Thickness Required*

Drill & Tap to 5/16-24



FlexFX[™] Cable Fittings for Metal

Sold in any quantity.

Cable railing and fittings made in USA from high quality 316 grade stainless steel. Designed to work for metal posts with 1/4" wall thickness. Drill and Tap to 5/16-24.

Level Fixed Fittings

Item #: **RFXMLN1/8** - 1/8" Fitting
Item #: **RFXMLN1/8-10** - 1/8" Fitting (10 Pack)

Item #: **RFXMLN3/16** - 3/16" Fitting



NON-TENSIONER

Level Tensioning Fittings

Item #: **RFXMLT1/8** - 1/8" Fitting
Item #: **RFXMLT1/8-10** - 1/8" Fitting (10 Pack)

Item #: **RFXMLT3/16** - 3/16" Fitting



TENSIONER

Bulk Cable

Item #: **RFXCABLE100** - 100' Spool of 1/8" Cable
Item #: **RFXCABLE500** - 500' Spool of 1/8" Cable

Item #: **RFXCABLE100-6** - 100' Spool of 3/16" Cable
Item #: **RFXCABLE500-6** - 500' Spool of 3/16" Cable



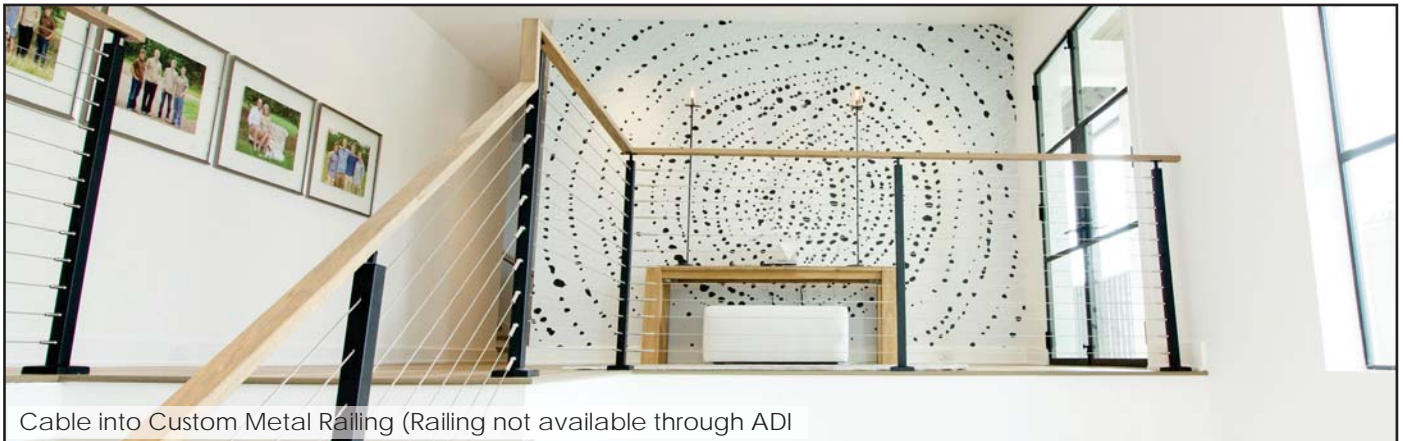

Cable into Custom Metal Railing (Railing not available through ADI)

Cable Railing for Metal - Stair



FOR METAL

1/4" post wall thickness required

Drill & tap to 5/16-24



FlexFXTM Cable Fittings for Metal

Sold in any quantity.

Cable railing and fittings made in USA from high quality 316 grade stainless steel. Designed to work for metal posts with 1/4" wall thickness. Drill and Tap to 5/16-24.

Stair Fixed Fittings

- Item #: **RFXMSN1/8** - 1/8" Fitting
- Item #: **RFXMSN1/8-10** - 1/8" Fitting (10 Pack)

- Item #: **RFXMSN3/16** - 3/16" Fitting



NON-TENSIONER

Stair Tensioning Fittings

- Item #: **RFXMST1/8** - 1/8" Fitting
- Item #: **RFXMST1/8-10** - 1/8" Fitting (10 Pack)

- Item #: **RFXMST3/16** - 3/16" Fitting



TENSIONER

Bulk Cable

- Item #: **RFXCABLE100** - 100' Spool of 1/8" Cable
- Item #: **RFXCABLE500** - 500' Spool of 1/8" Cable

- Item #: **RFXCABLE100-6** - 100' Spool of 3/16" Cable
- Item #: **RFXCABLE500-6** - 500' Spool of 3/16" Cable

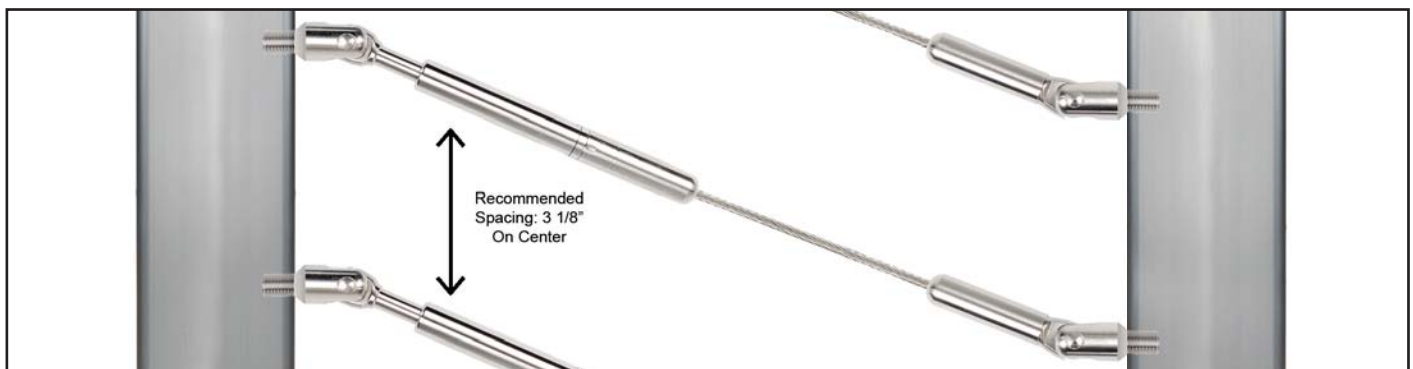

Cable Railing Kits for Metal Posts

Cable railing kit, made in USA from 1/8" high quality 316 grade stainless steel includes 1 strand of cable w/swage, applicable washers, Invisiware[®] receiver, Pull-Lock[™] end fitting and end cap. Minimum of 3" clearance between end post and structure is required. 29/64" hole diameter required for end posts to accommodate fittings.

212 Series Cable for 1-1/2" Metal Posts

Cable railing kit consists of 1-1/2" Invisiware receiver, 1-1/2" pull-lock fitting, delrin washers and 1 strand of cable.

- Item #: **21205** - 5' Cable Kit
- Item #: **21210** - 10' Cable Kit
- Item #: **21215** - 15' Cable Kit
- Item #: **21220** - 20' Cable Kit
- Item #: **21225** - 25' Cable Kit



232 Series Cable for 2" Metal Posts

Cable railing kit consists of 2" Invisiware receiver, 2" pull-lock fitting, delrin washers and 1 strand of cable.

- Item #: **23205** - 5' Cable Kit
- Item #: **23210** - 10' Cable Kit
- Item #: **23215** - 15' Cable Kit
- Item #: **23220** - 20' Cable Kit
- Item #: **23225** - 25' Cable Kit



252 Series Cable for 3" Metal Posts

Cable railing kit consists of 3" Invisiware receiver, 3" pull-lock fitting, delrin washers and 1 strand of cable.

- Item #: **25205** - 5' Cable Kit
- Item #: **25210** - 10' Cable Kit
- Item #: **25215** - 15' Cable Kit
- Item #: **25220** - 20' Cable Kit
- Item #: **25225** - 25' Cable Kit



* PLEASE ENSURE THAT METAL POSTS BEING USED ARE RATED FOR CABLE *

RED item numbers denote **NON STOCK** special order. Please allow for 7 - 10 day lead time.

Cable Railing Tools



Cable Cutters

Sold in any quantity.

Cable cutter designed for clean, burr free cutting of 1/8" stainless steel cable. Required for use with Push-lockTM and Pull-lockTM fittings.

Item #: RFXC7HIT - for 1/8" Cable
Item #: RFXC9 - for 3/16" Cable



Cable Gripping Pliers

Sold in any quantity.

Used to securely grip cable to avoid winding during installation which eliminates the most common issue of cables losing tension. Cable gripping pliers are recommended for professional installers.

Item #: RFXPLIERS



Push Lock Release Key

Sold in any quantity.

Release key allows the release of an untensioned cable from Pull-LockTM and Push-LockTM fittings. Also used to release fittings to aid installation.

Item #: RFXPLKEY/R

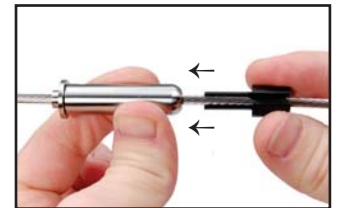

EZ-Clean Metal Cleaner / Protectant

Sold in any quantity.

Cleaner / Protector dissolves minor corrosion and leaves a protective coating that lasts for months. Includes 8 oz. rust and stain remover and 4 oz. bottle of protectant.

Item #: RFXEZCLEAN

ADITM

HORIZONTAL BALUSTER RAILING



Horizontal Baluster for Wood

pg 180 - 181

**DekPro™ Prestige Railing
w/ Horizontal Balusters**

pg 182 - 189

**Cascadia™ Stainless Steel
Horizontal Rod Railing**

pg 190 - 195

Horizontal Baluster Rail For Wood

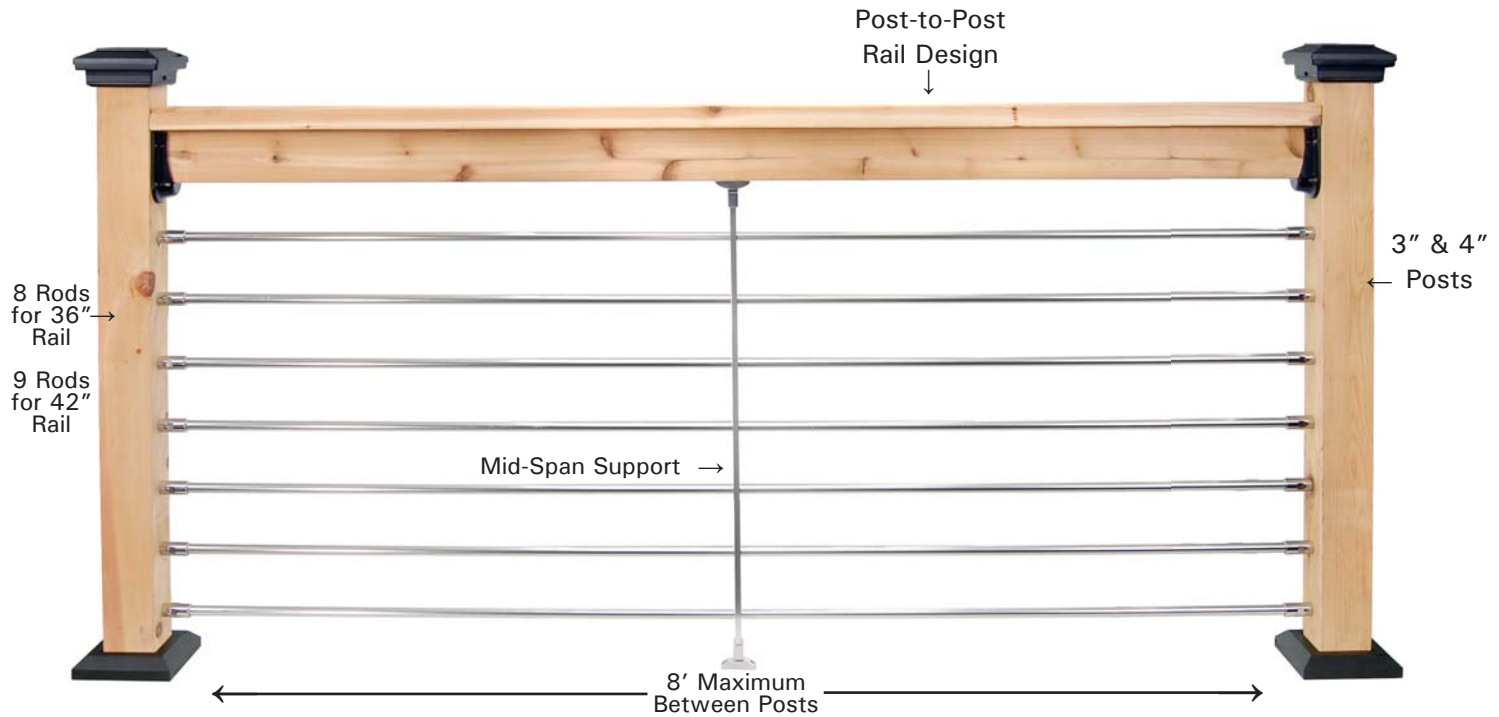

- Sleek, Modern Design
- 6' and 8' Lengths
- Field Trimmable to Length
- Level and Stair Railings
- 36" and 42" Rail Heights
- Easy Installation
- 5/8" Diameter Rods

Available Baluster Colors:



Black Textured

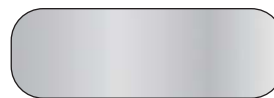

Anodized



Anodized Horizontal Balusters (Shown in Painted Wood Railing)

ACTUAL FREIGHT CHARGES APPLY TO ALL HORIZONTAL BALUSTER RAIL ORDERS



Horizontal Balusters Railing for Wood

Horizontal Baluster Kits for Wood Rail



Available in:

Black Text

Anodized

Level - Horizontal Baluster Infill Kits (8 Rods)

Sold in any quantity.

Horizontal baluster infill kits include 8 rods and all necessary components to complete this infill option for a 36" rail height. For 42" rail height an additional baluster will be required (9 total) - see page 185 for additional balusters and connectors - sold separately.

6' Rail Kit (5/8" x 72")

Item # 203061 - Black Textured
Item # 203060 - Anodized

8' Rail Kit (5/8" x 96")

Item # 203065 - Black Textured
Item # 203064 - Anodized



Available in:

Black Text

Anodized

Stair - Horizontal Baluster Infill Kits (8 Rods)

Sold in any quantity.

Stair horizontal baluster infill kits include 8 rods and all necessary components to complete this infill option for a 36" rail height. For 42" rail height an additional baluster will be required (9 total) - see page 185 for additional balusters and connectors - sold separately.

6' Rail Kit (5/8" x 72")

Item # 203063 - Black Textured
Item # 203062 - Anodized

8' Rail Kit (5/8" x 96")

Item # 203067 - Black Textured
Item # 203066 - Anodized

DekPro™ Prestige Railing

Horizontal Baluster Railing System

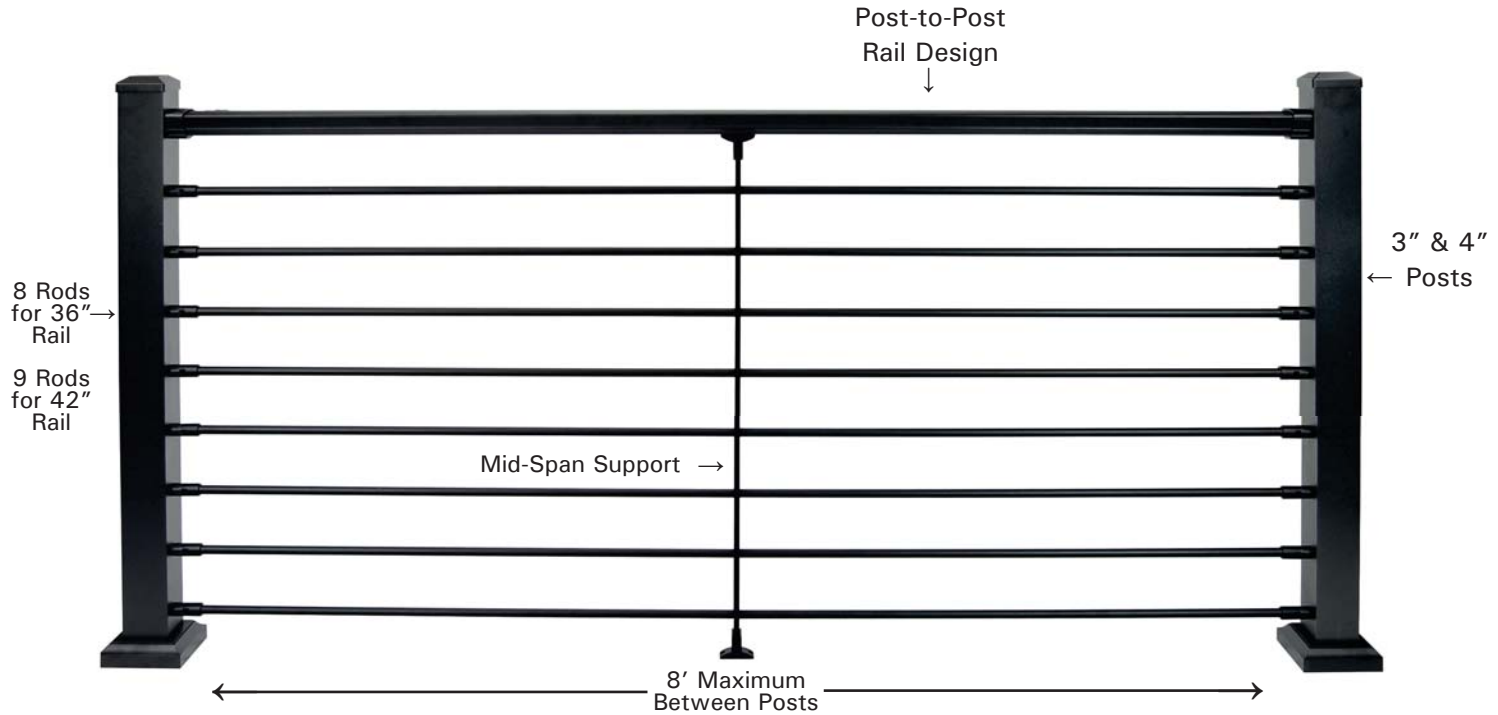

- Sleek, Modern Design
- 6' and 8' Lengths
- Field Trimmable to Length
- Level and Stair Railings
- 36" and 42" Rail Heights
- Easy Installation
- 5/8" Diameter Rods

Available Baluster Colors:



Black Textured



Anodized

3 Part Selection Process

Posts

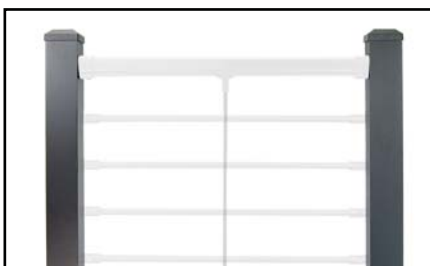

Top Rail / Brackets



Baluster Kits



ACTUAL FREIGHT CHARGES APPLY TO ALL DEKPROTM PRESTIGE RAIL ORDERS

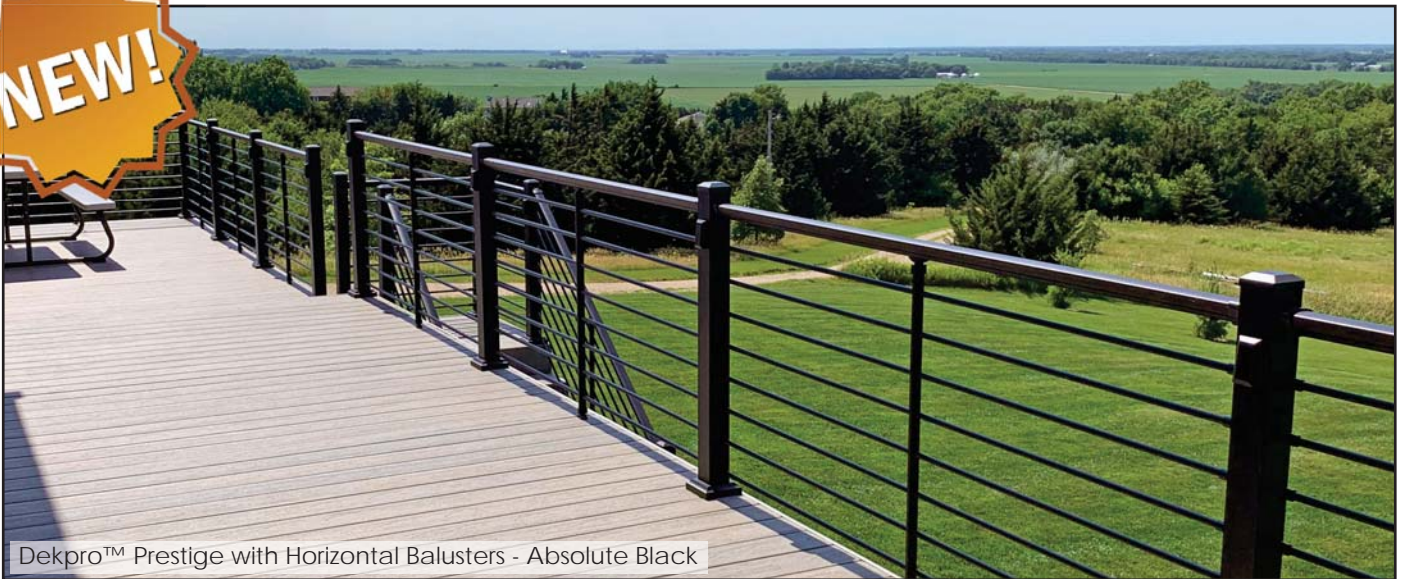

DekproTM Prestige with Horizontal Balusters - Absolute Black

Horizontal Baluster Kits for DekProTM Prestige



Available in:

Black Text

Anodized

Level - Horizontal Baluster Infill Kits (8 Rods)

Sold in any quantity.

Horizontal baluster infill kits include 8 rods and all necessary components to complete this infill option for a 36" rail height. For 42" rail height an additional baluster will be required (9 total) - see page 185. for additional balusters and connectors - sold separately.

6' Rail Kit (5/8" x 72")

Item # 203061 - Black Textured
Item # 203060 - Anodized

8' Rail Kit (5/8" x 96")

Item # 203065 - Black Textured
Item # 203064 - Anodized

Level Kit Includes:

- A. 8 - 5/8" Diameter Horizontal Balusters
- B. 16 - Level Horizontal Baluster Connectors w/ Fasteners
- C. 1 - Mid-Rail Support
- D. 2 - Mid-Rail Support Connector Shoes w/ Fasteners

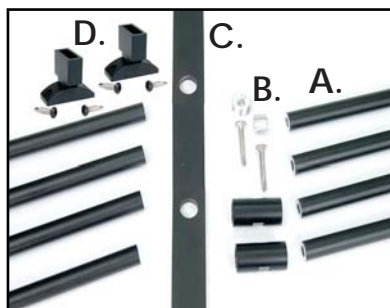

Post Jig

Sold in any quantity.

Quick Jig rail guide allows the installer to easily locate and fasten top rail bracket as well as locate horizontal baluster railing without having to measure or center manually.
Fits 3" post, but can be used on 4" post if reversed (2-way level may have to be removed for 4" post)

Item # PRJIG3RR - 3" post jig for rod rail

